



UC PHONE
DW-620G

User Manual

Table of Content

Figures	6
Tables.....	6
1 Safety Instruction.....	10
2 Overview	11
3 Installation	12
3.1 Use PoE or External Power Adapter	12
3.2 Desktop and Wall-mount Installation.....	13
4 Introduction to the Phone User Interface	15
4.1 Keypad	15
4.2 Using Handset / Hands-free Speaker / Headphone	16
4.3 Screen User Interface.....	17
4.4 Web Portal.....	18
5 Setting Up	19
5.1 Network Configuration.....	19
5.2 Line Configurations	20
6 Using the Phone.....	26
6.1 Making Phone Calls	26
6.1.1 Make / Receive Second Call	30
6.1.2 Join / Split Two Calls (3-way Local Conference)	31
6.1.3 Call Transfer.....	31
6.2 Using Phonebook.....	32
6.2.1 Add / Edit / Delete Contact.....	33
6.2.2 Add / Edit / Delete Group	34
6.2.3 Browse and Add / Remove Contacts in Group	34
6.3 Using Cloud Phonebook	35
6.3.1 Open Cloud Phonebook.....	36
6.4 Call Logs.....	36
6.5 Voice Message	38
6.6 Do-Not-Disturb	39
6.7 Auto-Answering.....	40
6.8 Call Forward	41
6.9 DSS LCD Configuration.....	43
7 Phone Settings	45
7.1 Adjust Audio Volume	45
7.2 Set Ring Tone Volume and Type.....	45

7.3 Adjust LCD Energy saving.....	45
7.4 Set Device Time/Date	46
7.5 Set Device Language.....	47
7.6 Reboot the Device.....	47
7.7 Reset to Factory Default.....	47
8 Web Portal	48
8.1 Web Portal Authentication.....	48
8.2 Web Call.....	48
8.3 SYSTEM / Information	49
8.4 SYSTEM / Account.....	49
8.5 SYSTEM / Configurations.....	49
8.6 SYSTEM / Upgrade.....	50
8.7 SYSTEM / Auto Provision.....	50
8.8 SYSTEM / Tools	50
8.9 NETWORK / Basic	50
8.10 NETWORK / Advanced	50
8.11 NETWORK / VPN	50
8.12 LINES / SIP	50
8.13 LINES / Dial Peer	54
8.14 LINES / Dial Plan.....	58
8.15 LINES / Basic Settings.....	58
8.16 PHONE / Features	59
8.17 PHONE / Audio.....	61
8.18 PHONE / MCAST.....	62
8.19 PHONE / Time/Date.....	63
8.20 PHONE / Advanced.....	64
8.21 PHONEBOOK / Contacts	64
8.22 PHONEBOOK / Cloud Phonebook.....	64
8.23 PHONEBOOK / Blacklist.....	65
8.24 PHONEBOOK / Advanced	65
8.25 CALL LOGS	65
8.26 FUNCTION KEY / Function Key	65
8.27 FUNCTION KEY / EXT Key	67
8.28 FUNCTION KEY / Softkey	67
9 Advanced Features	68
9.1 VPN	68
9.1.1 L2TP.....	68
9.1.2 OpenVPN.....	69

10 Trouble Shooting	70
10.1 Get Device System Information	70
10.2 Upgrade to the Latest Software	70
10.3 Reboot Device	70
10.4 Reset Device to Factory Default	70
10.5 Network Packets Capture	71
10.6 Entering Post Mode and Recover System Image	71
10.7 Common Trouble Cases	72
Appendix I - Icon Illustration	73
Appendix II – Text Input from Keypad	74
Appendix III – LED Definition	76

Figures

Figure 1	- Desktop Installation	13
Figure 2	- Wall-mount Installation	13
Figure 3	- Connecting to the Device	14
Figure 4	- Keypad.....	15
Figure 5	- Screen Layout / Default Standby Screen.....	17
Figure 6	- Vertical Scroll Bar.....	17
Figure 7	- Check the Device's IP Address	18
Figure 8	- Web Portal Login Page.....	18
Figure 9	- Configure SIP Proxy Server Address	20
Figure 10	- Configure SIP Proxy Server Port.....	20
Figure 11	- Configure SIP Username	21
Figure 12	- Configure Authentication Name	21
Figure 13	- Configure SIP Authentication Password.....	21
Figure 14	- Configure Display Name	22
Figure 15	- Enable / Disable Outbound Proxy.....	22
Figure 16	- Enable / Disable Sip Line.....	22
Figure 17	- Configure Advanced Line Options.....	23
Figure 18	- Configure SIP Realm/Domain	23
Figure 19	- Configure Unregistered Dial	23
Figure 20	- Enable / Disable Anonymous	23
Figure 21	- Configure DTMF Mode	23
Figure 22	- Enable / Disable STUN	24
Figure 23	- Configure Local Port.....	24
Figure 24	- configure Ring Type.....	24
Figure 25	- Configure MWI Number.....	24
Figure 26	- Configure Pickup Number.....	24
Figure 27	- Configure Park Number	24
Figure 28	- Configure Join Call Number	25
Figure 29	- Enable / Disable Missed Call	25
Figure 30	- Enable / Disable Feature Sync	25
Figure 31	- Enable / Disable SCA.....	25
Figure 32	- Default Line	26
Figure 33	- Dialing a Number before Audio Channel Opened.....	27
Figure 34	- Dial a Number after Audio Channel Opened.....	27
Figure 35	- Calling Remote Party.....	28

Figure 36	- Incoming Call Screen	28
Figure 37	- Talking Mode Screen	29
Figure 38	- Call Holding Screen	29
Figure 39	- Second Incoming Call Screen	30
Figure 40	- Dual Calls.....	30
Figure 41	- Conference Call.....	31
Figure 42	- Phonebook Screen.....	32
Figure 43	- Phonebook is Empty.....	32
Figure 44	- Browsing Phonebook.....	33
Figure 45	- Add New Contact	33
Figure 46	- Group List.....	34
Figure 47	- Browsing Contacts in a Group.....	34
Figure 48	- Add/Remove Contacts in a Group.....	35
Figure 49	- Cloud Phonebook List.....	35
Figure 50	- Downloading Cloud Phonebook.....	36
Figure 51	- Browsing Contacts in Cloud Phonebook	36
Figure 52	- Call Logs	37
Figure 53	- Filter Call Log Type	37
Figure 54	- New Voice Message Notification	38
Figure 55	- Voice Message Screen	38
Figure 56	- Configure the Voice Message Number.....	39
Figure 57	- DND Enabled on All Lines	39
Figure 58	- Configure DND on Line	40
Figure 59	- Configure Auto-answering on Line1.....	41
Figure 60	- Auto-answering Enabled on Line1	41
Figure 61	- Select Line for Call Forward Configuration	42
Figure 62	- Select Call Forward Type.....	42
Figure 63	- Activate Call Forward and Configure Call Forward Number	43
Figure 64	- Set Delay Time for Call Forward on No Answer	43
Figure 65	- DSS Page Configuration Screen.....	43
Figure 66	- DSS Key Page Configuration.....	44
Figure 67	- Web Call Controls.....	48
Figure 68	- Web Call, Entering Number and Select Line	48
Figure 69	- Global Substitution Configuration	55
Figure 70	- Local Substitution Configuration	56
Figure 71	- Add Prefixes Configuration.....	56
Figure 72	- Add Suffixes Configuration.....	57

Figure 73 - Deletion Configuration57
Figure 74 - Dial Plan Configuration58
Figure 75 - EXT key Configuration67
Figure 76 - Softkey Configuration67

Tables

Table 1 - Time Settings Parameters	46
Table 2 - SIP Settings for Lines on Web	50
Table 3 - Dial Peer Settings for Lines on Web	54
Table 4 - Global Settings for Lines on Web	58
Table 5 - Common Phone Feature Settings on Web	59
Table 6 - Audio Settings on Web	61
Table 7 - MCAST Parameters on Web	63
Table 8 - Time/Date Setting Parameters on Web	63
Table 9 - DSS Key Setting Parameters on Web	66
Table 10 - Trouble Cases	72
Table 11 - Keypad Icons	73
Table 12 - Status Prompt and Notification Icons	73
Table 13 - Look-up Table of Characters	74
Table 14 - DSS KEY LED State	76

1 Safety Instruction

Please read the following safety notices before installing or using this unit. They are crucial for the safe and reliable operation of the device.

- Please use the external power supply that is included in the package. Other power supply may cause damage to the phone, affect the behavior or induce noise.
- Before using the external power supply in the package, please check the home power voltage. Inaccurate power voltage may cause fire and damage.
- Please do not damage the power cord. If power cord or plug is impaired, do not use it, it may cause fire or electric shock.
- Do not drop, knock or shake the phone. Rough handling can break internal circuit boards.
- This phone is design for indoor use. Do not install the device in places where there is direct sunlight. Also do not put the device on carpets or cushions. It may cause fire or breakdown.
- Avoid exposure the phone to high temperature or below 0°C or high humidity.
- Avoid wetting the unit with any liquid.
- Do not attempt to open it. Non-expert handling of the device could damage it. Consult your authorized dealer for help, or else it may cause fire, electric shock and breakdown.
- Do not use harsh chemicals, cleaning solvents, or strong detergents to clean it. Wipe it with a soft cloth that has been slightly dampened in a mild soap and water solution.
- When lightning, do not touch power plug, it may cause an electric shock.
- Do not install this phone in an ill-ventilated place. You are in a situation that could cause bodily injury. Before you work on any equipment, be aware of the hazards involved with electrical circuitry and be familiar with standard practices for preventing accidents.

2 Overview

The new DW-620G color screen IP Phone is a high-end enterprise desktop phone which comes with intelligent LCD the DSS Key-mapping to increase enterprise users' productivity at a cost-effective price.

The DSS Key-mapping is designed with intelligence to support dynamic usage to substitute expansion modules. There are 9 DSS keys corresponded to the color LCD display to provide dynamic Line/DSS/BLF functions up to four pages at virtualized total 36 DSS keys. User may configure/customize each DSS key in each page. Every DSS key has a LED indication in green, red, and yellow colors to reflect the key state. A page shortcut button is also designed to allow user to quickly switch between pages. DW-620G is the most economic choice for SMB office and enterprise supervisors.

DW-620G inherits all features from enterprise phones, such as HD voice in handset, headset, and full-duplex speakerphone modes, PoE, Fast/Gigabit Ethernet, QoS, secure transmission, auto-provisioning, and more.

DW-620G is a great office productivity appliance for enterprise users. The old DSS key label is inconvenient and not environmental friendly. DW-620G's intelligent LCD the DSS Key-mapping provides users the flexibility to change DSS key definition and display through easy configuration. Meanwhile, with its intelligent design of the DSS key, it can be multiplied as expansion modules to save space and cost. DW-620G will provide the best user experience to advance enterprise users.”

In order to help some users who are interested to read every detail of the product, this user manual is provided as a user's reference guide. Still, the document might not be up to date with the newly release software, so please kindly download updated the latest user manual from website, or contact with support if you have any question using DW-620G.

3 Installation

3.1 Use PoE or external Power Adapter

DW-620G, called as 'the device' hereafter, supports two power supply modes, power supply from external power adapter and supports 802.3af Class 2 Power over Ethernet.

PoE power supply saves the space and cost of providing the device additional power outlet. With a PoE switch, the device can be powered through a single Ethernet cable which is also used for data transmission. By attaching UPS system to PoE switch, the device can keep working at power outage just like traditional PSTN telephone which is powered by the telephone line.

For users who do not have PoE equipment, the traditional power adapter should be used. If the device is connected to a PoE switch and power adapter at the same time, the power adapter will be used in priority and will switch to PoE power supply at power failure on the power adapter.

Please use the power adapter supplied and the PoE switch met the specifications to ensure the device worked properly.

3.2 Desktop and Wall-mount Installation

The device supports two installation mode, desktop and wall-mount. To set up the phone to be used on desktop, please follow the instructions in below picture to install the device.

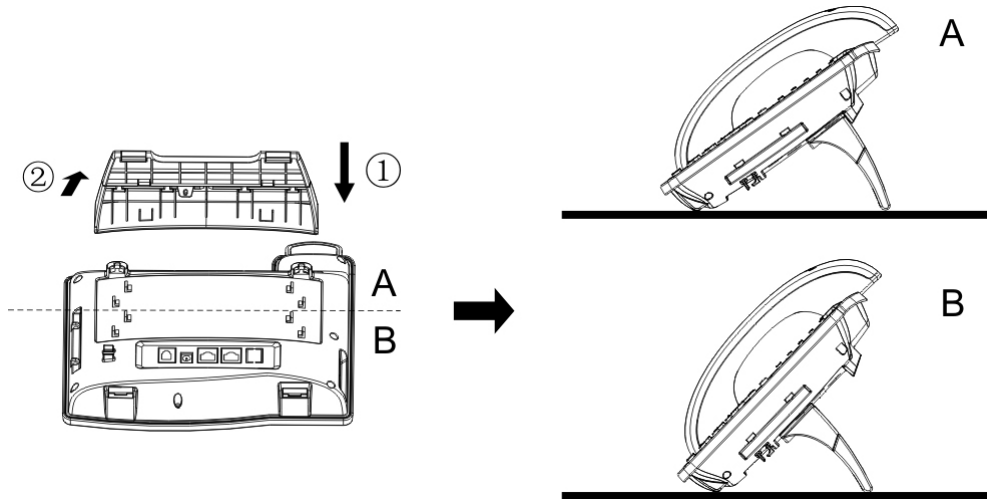

Figure 1 - Desktop Installation

To mount the device on the wall, please follow the instructions in below picture.

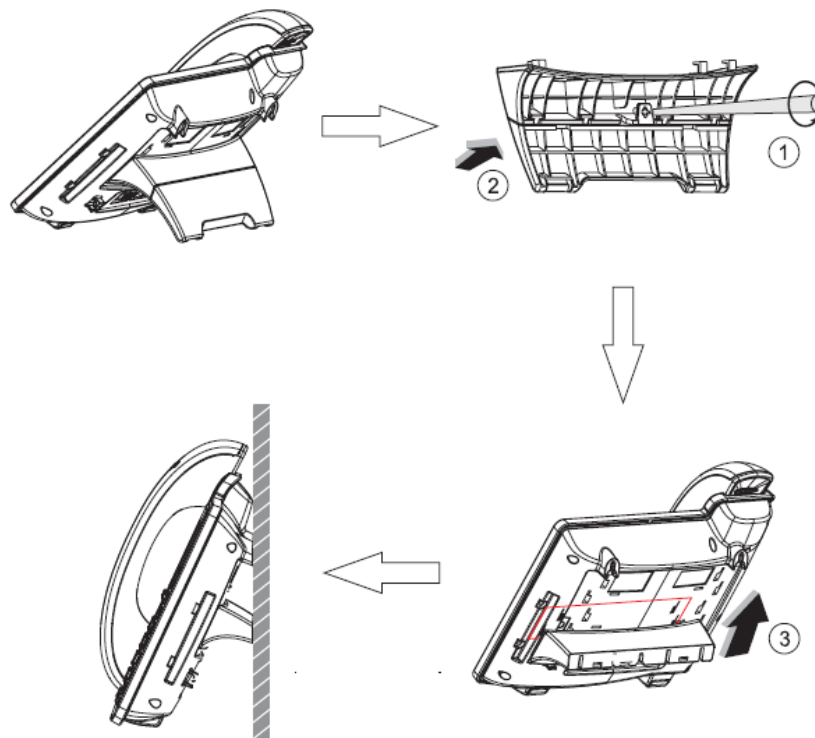

Figure 2 - Wall-mount Installation

Please connect power adapter, network, PC, handset, and headphone to the corresponding ports as described in below picture.

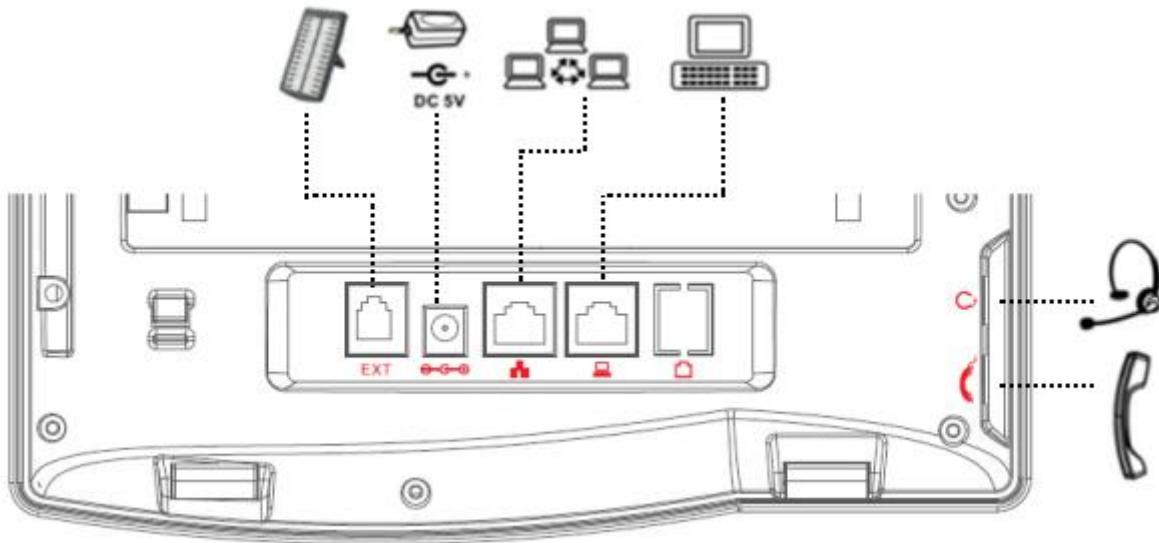

Figure 3 - Connecting to the Device

4 Introduction to the Phone User Interface

4.1 Keypad

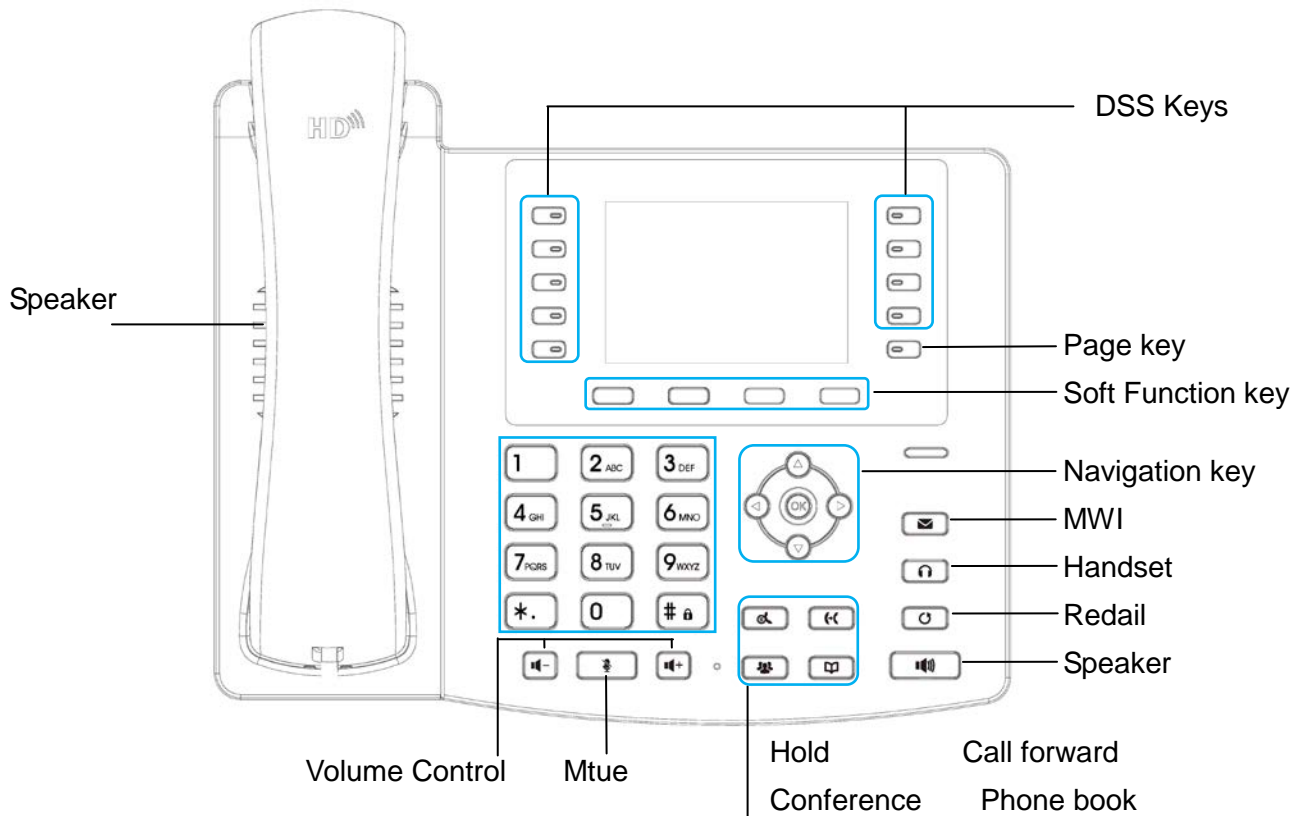

Figure 4 - Keypad

The above picture shows the keypad layout of the device. Each key provides its own specific function. User should refer to the illustration in this section about the usage of each key and the description in this document about each function.

Some keys support long-pressing function. User can press and hold the key for 1.5 seconds to trigger the long-pressed function.

- Soft keys – These four buttons provide different functions corresponding to the soft-menu displayed on the screen.
- Standard Telephone Keys – The 12 standard telephone keys provide the same function as standard telephones, but further to the standard function, some keys also provide special function by long-pressing the key.
 - Key **#** - Long-pressed to lock the phone. (Default PIN is 123)
 - Key **Page** - Long-pressed to open LCD page configuration.

- Navigation Keys – User can press up/down navigation keys to change line focus in talking screen or move cursor in a screen with list items; in some configuration or text editor screen, user can press left/right navigation keys to switch option or move cursor to the left / right.
- Redial – By pressing 'Redial' button, user can redial the last dialed number.
- Hands-free Speaker – By pressing this button once, user can turn on the audio channel of hands-free speaker
- Microphone Mute – User can mute the microphone with this button during talking mode.
- Volume +/- – In standby, ringing, ring configuration screen, user can press 2 buttons to lower/increase the ringtone volume, in talking and audio volume adjustment screen, user can press this button to lower/increase the audio volume.

4.2 Using Handset / Hands-free Speaker / Headphone

■ Using Handset

To talk over handset, user should lift the handset off the device and dial the number, or dial the number first, then lift the handset and the number will be dialed. User can switch audio channel to handset by lifting the handset when audio channel is opened in speaker or headphone.

■ Using Hands-free Speaker

To talk over hands-free speaker, user should press the hands-free button then dial the number, or dial the number first then press the hands-free button. User can switch audio channel to the speaker from handset by pressing the hands-free button when audio channel is opened in handset.

■ Using Headphone

To use headphone, by default, user should headset button which is defined by DSS key to turn on the headphone. Same as handset and hands-free speaker, user can dial the number before or after headphone turned on.

■ Using Line Keys(Defined by DSS Key)

User can use line key to make or answer a call on specific line. If handset has been lifted, the audio channel will be opened in handset, otherwise, the audio channel will be opened in hands-free speaker or headphone.

4.3 Screen User Interface



Figure 5 - Screen Layout / Default Standby Screen

The screen user interface is mostly presented in the above layout except some prompt messages. The upper area is the main screen to display the device's status and information or data for viewing or editing. The lower area is the software menu (soft-menu) buttons which will change against user's action or device's status.

The above picture shows the default standby screen which is also the root of the soft-menu. The default standby screen shows the greeting words and effective feature indications like voice message, missed call, auto-answering, do-not-disturb, call forward, lock state, and the network connectivity. User can get back to the default standby screen mostly by lifting and putting by the handset.

The icon illustration is described in **Appendix I - Icon Illustration**.

In some screens, there are more items or long text to be displayed which could not fit into the screen. They will be arranged in a list or multiple lines with a scroll bar. If user sees a scroll bar, user can use up/down navigation buttons to scroll the list. By long-pressed the navigation keys, user can scroll the list or items in a faster speed.

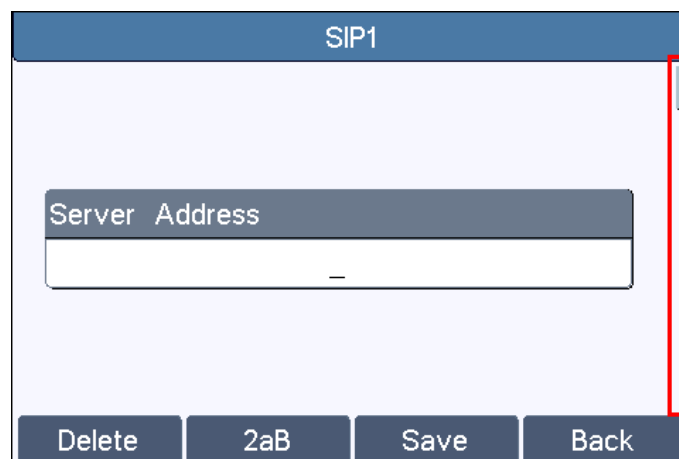

Figure 6 - Vertical Scroll Bar

4.4 Web Portal

User can also use the device's web portal to manage or operate the device. User should open the device's web portal page by entering the device's IP address in a browser. To get the device IP address, user could press the soft-menu button [Menu] -> [Status] or by pressing [Down] navigation key.

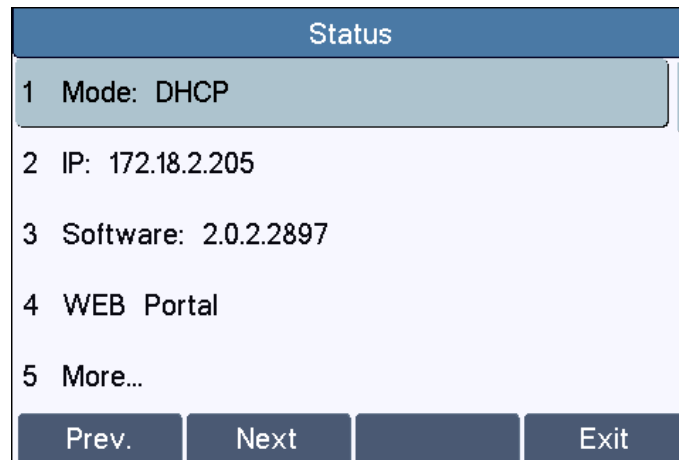

Figure 7 - Check the Device's IP Address

The first screen of the device's web portal is the login page.

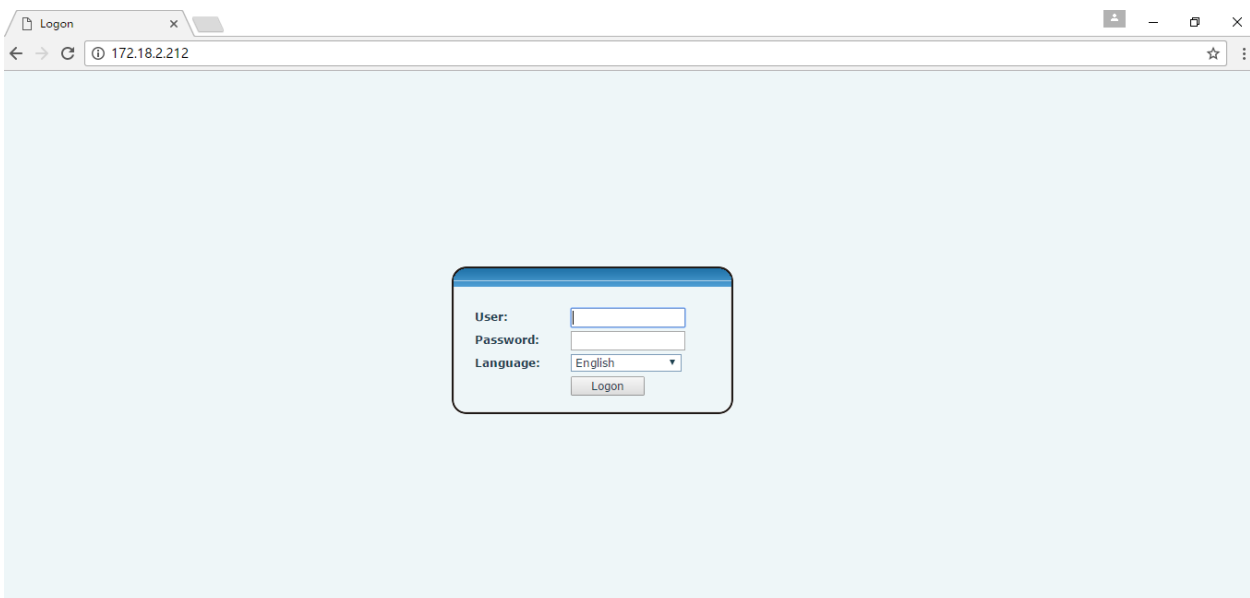

Figure 8 - Web Portal Login Page

User must enter the username and password to log in to the web portal. **The default username and password are both 'admin'**. For the detail of web portal operations, please refer to **8 Web Portal**.

5 Setting Up

In order to get the device ready for making and receiving phone calls, the device must be configured with correct network configurations and at least one of the lines must be configured with an SIP telephony service.

5.1 Network Configuration

The device relies on IP network connection to provide service. Unlike traditional phone system based on a circuit switched wire technology, IP devices are connected to each other over the network and exchange data in packet basis based on the devices' IP address.

To enable the device, the network parameters must be configured properly first. To configure network parameters, user should open the network configuration screen through soft-menu [Menu] -> [Settings] -> [Advanced Settings] -> [Network] -> [Network Settings] from standby screen.

NOTICE! If user saw a  'Network Disconnected' icon flashing in the middle of screen, it means the network cable was not correctly connected to the device's network port. Please check the cable is connected correctly to the device and to the network switch, router, or modem.

There are three common IP configuration modes.

- Dynamic Host Configuration Protocol (DHCP) – This is the automatic configuration mode by getting network configurations from a DHCP server. Users need not to configure any parameters manually. All configuration parameters will be getting from DHCP server and applied to the device. This is recommended for most users.
- Static IP Configuration – This option allows user to configure each IP parameters manually, including IP Address, Subnet Mask, Default Gateway, and DNS servers. This is usually used in an office environment or by power users.
- PPPoE – This option is often used by users who connect the device to a broadband modem or router. To establish a PPPoE connection, user should configure username and password provided by the service provider.

The device is default configured in DHCP mode.

5.2 Line Configurations

A line must be configured properly to be able to provide telephony service. The line configuration is like a virtualized SIM card. Just like a SIM card on a mobile phone, it stores the service provider and the account information used for registration and authentication. When the device is applied with the configuration, it will register the device to the service provider with the server's address and user's authentication as stored in the configurations.

To configure a line manually, user may open the line configuration screen through soft-menu button [Menu] -> [Settings] -> [Advanced Settings] -> [Accounts] -> [SIP1] / [SIP2] / [SIP3] / [SIP4] / [SIP5] / [SIP6] -> [Basic Settings] from the standby screen.

NOTICE! User must enter correct PIN code to be able to advanced settings to edit line configuration. (The default PIN is 123)

The parameters and screens are listed in below pictures.

Figure 9 - Configure SIP Proxy Server Address

Figure 10 - Configure SIP Proxy Server Port

8207

Username

8207

Delete 2aB Save Back

Figure 11 - Configure SIP Username

8207

Auth. User

8207

Delete 2aB Save Back

Figure 12 - Configure Authentication Name

8207

Auth. Password

Delete 2aB Save Back

Figure 13 - Configure SIP Authentication Password

8207

Display Name

8207_

Delete 2aB Save Back

Figure 14 - Configure Display Name

8207

Outbound Proxy

Disabled

Save Back

Figure 15 - Enable / Disable Outbound Proxy

8207

Registration

Enabled

Save Back

Figure 16 - Enable / Disable Sip Line

Save the adjustment by pressing [OK] or [Save] when done.

For users who want to configure more options, user should use web management portal to modify or

Advanced Settings in accounts on the individual line to configure those options.

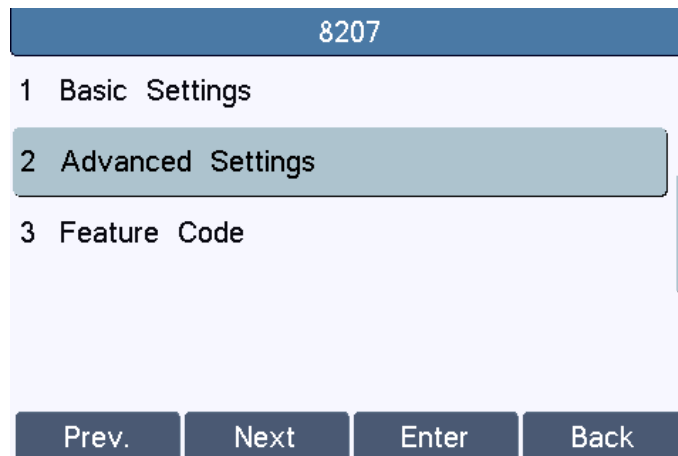

Figure 17 - Configure Advanced Line Options

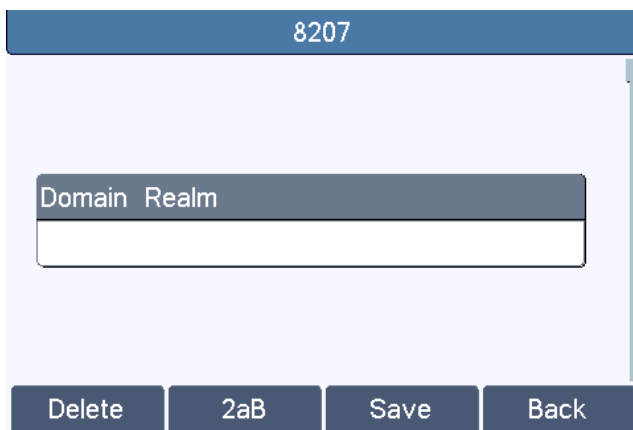

Figure 18 - Configure SIP Realm/Domain

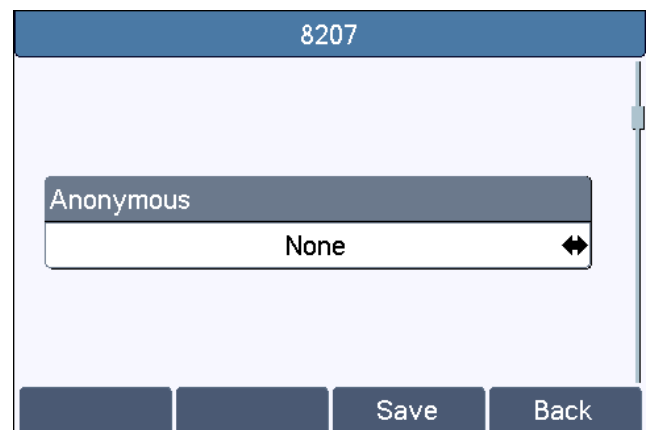

Figure 20 - Enable / Disable Anonymous

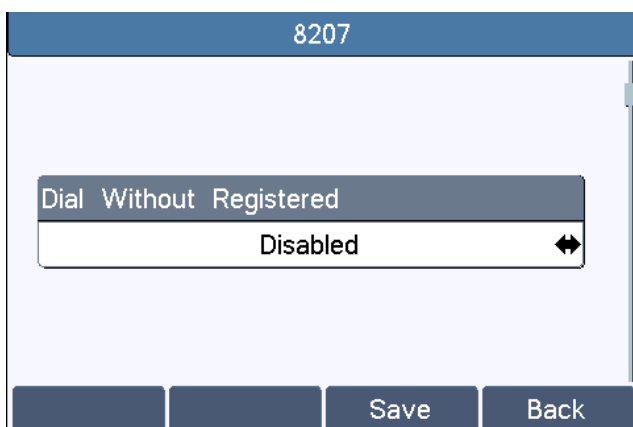

Figure 19 - Configure Unregistered Dial

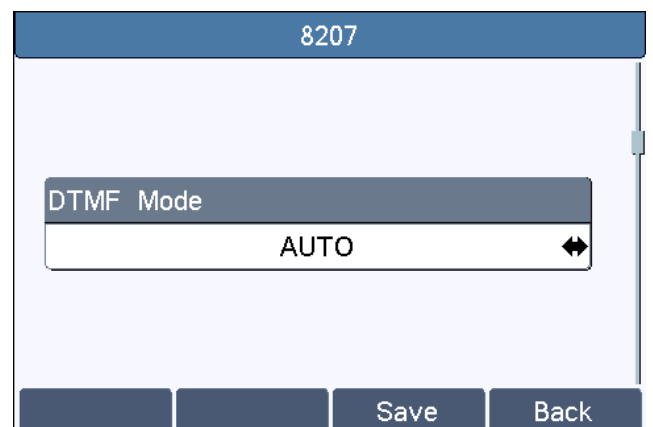

Figure 21 - Configure DTMF Mode

8207

Use STUN

Disabled

Save Back

Figure 22 - Enable / Disable STUN

8207

MWI Number

123456

Delete 123 Save Back

Figure 25 - Configure MWI Number

8207

Local Port

5060

Delete Save Back

Figure 23 - Configure Local Port

8207

Pickup Number

999

Delete 123 Save Back

Figure 26 - Configure Pickup Number

8207

Ring Type

Default

Save Back

Figure 24 - configure Ring Type

8207

Park Number

888_

Delete 123 Save Back

Figure 27 - Configure Park Number

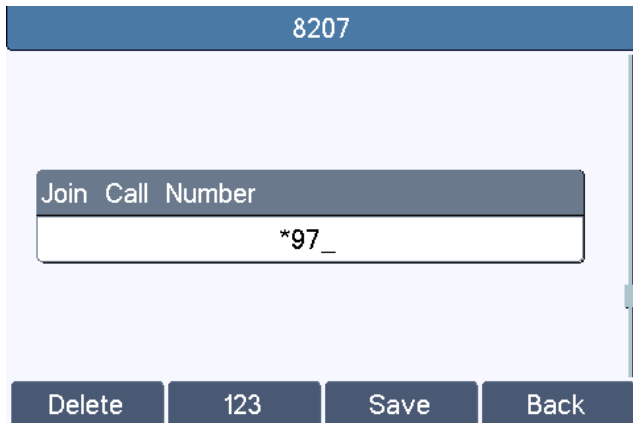

Figure 28 - Configure Join Call Number

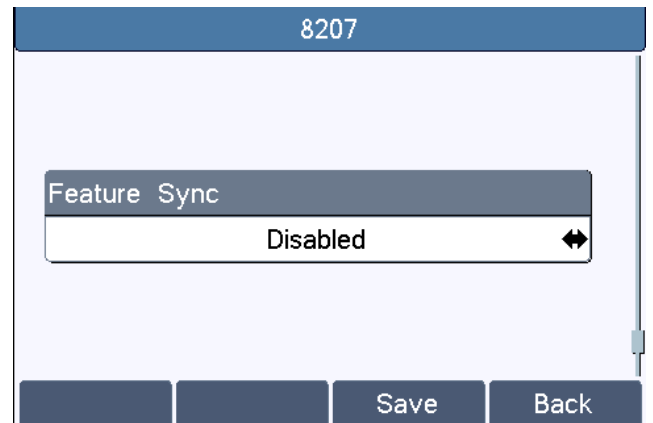

Figure 30 - Enable / Disable Feature Sync

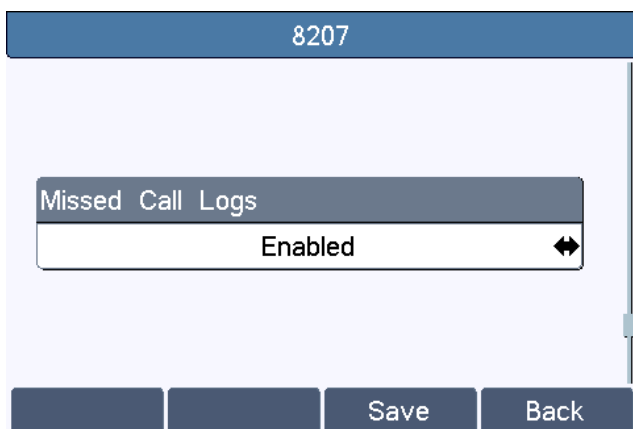

Figure 29 - Enable / Disable Missed Call

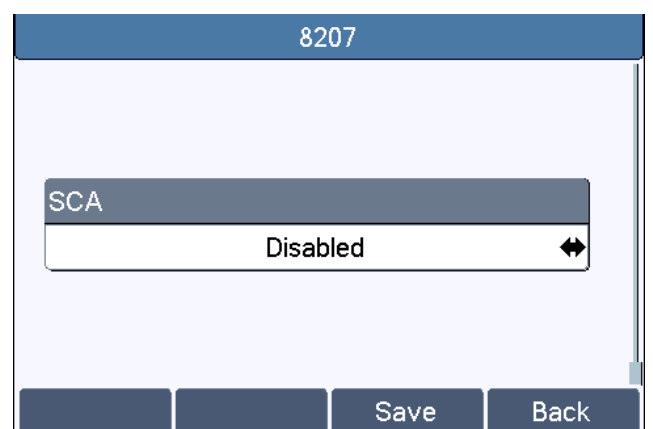

Figure 31 - Enable / Disable SCA

NOTICE! On the device, user can only configure whether STUN / Outbound Proxy is enabled, to change the STUN / Outbound Proxy server address, user must edit in the device web portal. (Refer to 8.15 LINES / Global Settings and 8.12 LINES / SIP)

6 Using the Phone

6.1 Making Phone Calls

■ Default Line

The device provides 5 line services. If both lines are configured, user can make or receive phone calls on either line. If default line is configured by user, there will be a default line to be used for making outgoing call which is indicated on the top left corner. To change the default line, user can press up/down navigation buttons to switch between two lines. Enable or disable default line, user can press [Menu] -> [Features] -> [Default Line] or configure from Web Interface (Web / Phone settings / Features).



Figure 32 - Default Line

■ Dialing Methods

User can dial a number by,

- Entering the number directly
- Selecting a phone number from phonebook contacts (Refer to **6.2 Using Phonebook**)
- Selecting a phone number from cloud phonebook contacts (Refer to **6.3 Using Cloud Phonebook**)
- Selecting a phone number from call logs (Refer to **6.4 Call Logs**)
- Redialing the last dialed number

■ Dialing Number then Opening Audio

To make a phone call, user can firstly dial a number by one of the above methods. When the dialed number is completed, user can press [Dial] button on the soft-menu, or press hand-free button to turn on the speaker or headphone, or lift the handset to call out with the current line, or user can press line key (Configured by DSS Keys) to call out with specified line.

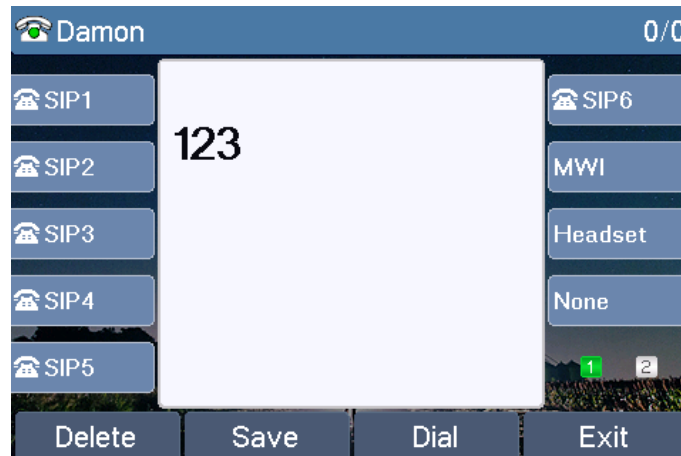

Figure 33 - Dialing a Number before Audio Channel Opened

■ **Opening Audio then Dialing the Number**

Another alternative is the traditional way to firstly open the audio channel by lifting the handset, turning on the hands-free speaker or headphone by pressing hands-free button, or line key, and then dial the number with one of the above methods. When number dialed completed, user can press [Dial] button or [OK] button to call out, or the number will be dialed out automatically after timeout.

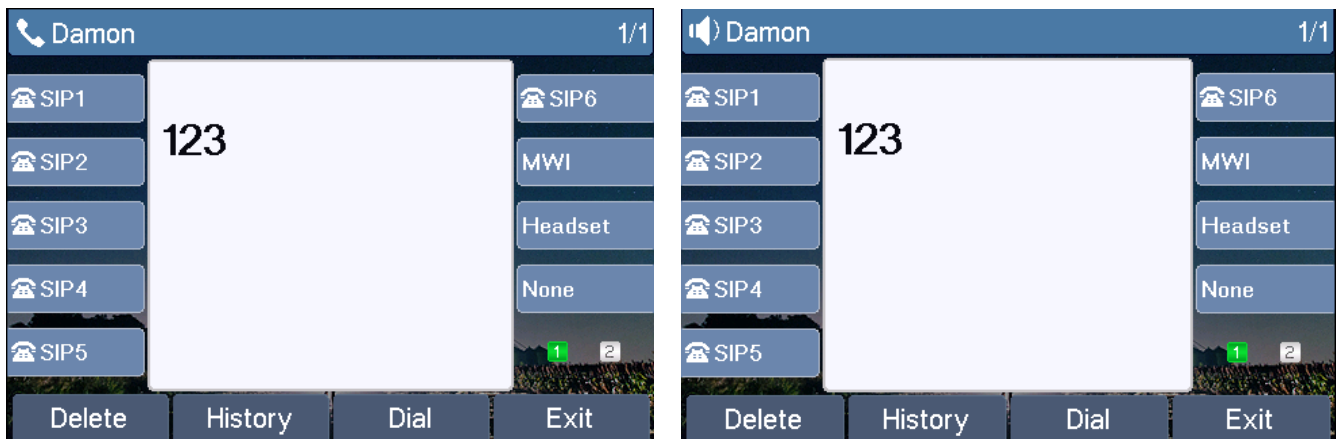

Figure 34 - Dial a Number after Audio Channel Opened

NOTICE! For some users who get used to dial a number immediately by pressing **#** key, the user must login to the web to enable 'Press "#" to invoke dialing' option in page [Line] -> [Dial Plan] -> "Basic Settings" and apply it.

■ **Cancel Call**

While calling the number, user can press [End] button or close the audio channel by put back the handset or press the hands-free button to drop the call.



Figure 35 - Calling Remote Party

■ **Answering Incoming Call**

When there is an incoming call while the device is idle, user will see the following incoming call alerting screen



Figure 36 - Incoming Call Screen

User can answer the call by lifting the handset, open headphone or speaker phone by pressing the hands-free button, or the [OK] / [Answer] button. To divert the incoming call, user should press [Divert] button. To reject the incoming call, user should press [Reject] button.

■ Talking

When the call is connected, user will see a talking mode screen as the following figure.



Figure 37 - Talking Mode Screen

1. **Audio Channel** – The icon reflects the current audio channel being used.
2. **Current Line** – The line is being used on the call.
3. **Remote Party** – The name or number of the remote party.
4. **Talking time** – The time passed since the call established.
5. **Screen Pages** – The number of screen pages. User can press up/down navigation buttons to switch screen page.

■ Call Holding /Resuming

User can hold the remote party by pressing [Hold] button and the button will be changed to [Resume] icon. User can press the [Resume] button to resume the call.



Figure 38 - Call Holding Screen

■ Call Ended

When user finished the call, user can put the handset back to the device to hang up the call or press the hands-free button to close the audio channel to hang up.

NOTICE! When the call is held or in holding state, the user must press [Resume] button to back to call mode, or putting the handset back to the device or pressing Speaker-free button to hang up is not available.

6.1.1 Make / Receive Second Call

The device can support up to multichannel concurrent calls. When there is already a call established, user can still answer another incoming call on either lines or make a second call on either lines.

■ Second Incoming Call

When there is another incoming call during talking a phone call, this call will be waiting for user to answer it. User will see the call message in the middle of current screen. The device will not be ringing but playing call waiting tone in the audio channel of the current call and the LED will be flashing in green. User can accept or reject the call same as normal incoming call. When the waiting call is answered, the first call will be put on hold automatically.

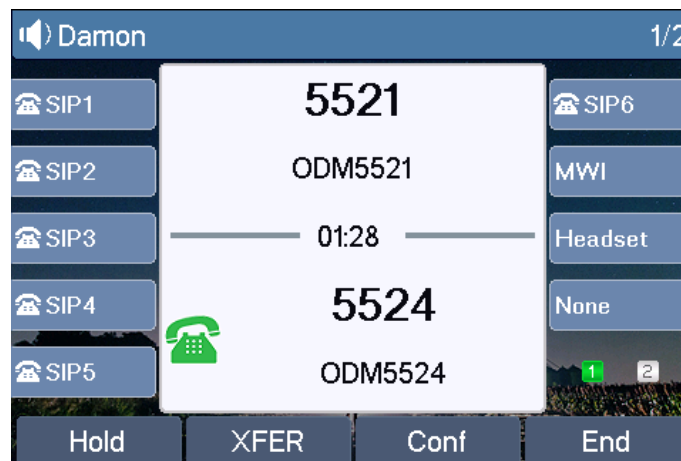

Figure 39 - Second Incoming Call Screen

■ Second Outgoing Call

To make a second call, user may press [XFER] / [Conf] button to make a new call on the default line or press the line key to make new call on specific line. Then dial the number the same way as making a phone call. Another alternative for making second call is to pressing DSS Keys dial out from the configured Keys (BLF/Speed Dial). When user is making a second call with the above methods, the first call could be place on hold manually first or will be put on hold automatically at second dial.

■ Switching between Two Calls

When there are two calls established, user will see a dual calls screen as the following picture

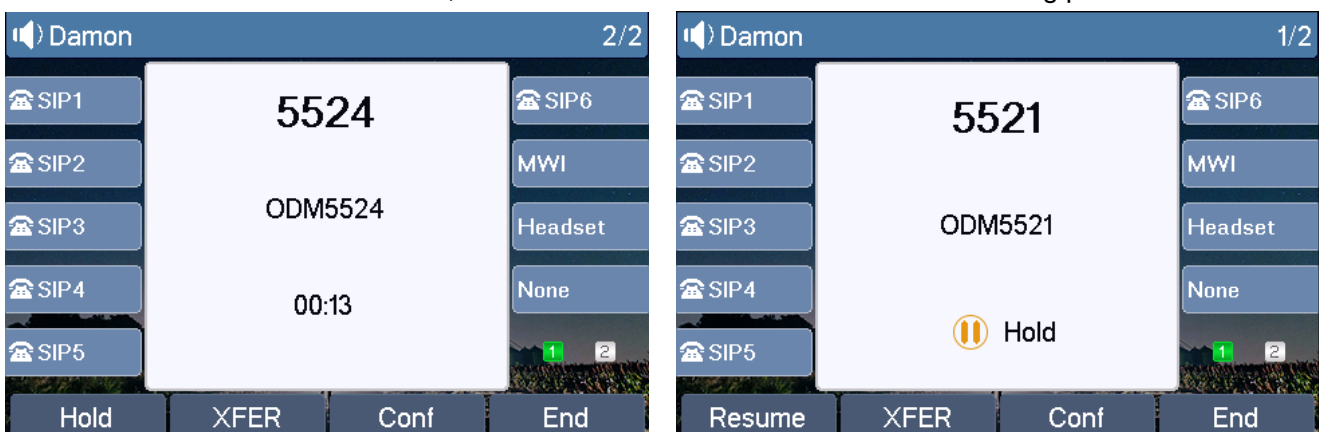

Figure 40 - Dual Calls

User can press up/down navigation buttons to switch screen page, and switch call focus by pressing [Hold] / [Resume] button.

■ Ending One Call

User may hang up the current talking call by closing the audio channel or press [End] button. The device will return to single call mode in holding state.

6.1.2 Join / Split Two Calls (3-way Local Conference)

In the dual call mode, user can join two calls into a conference call by pressing [Conf] button. When two calls are joined, user can split them by pressing [Split] button.

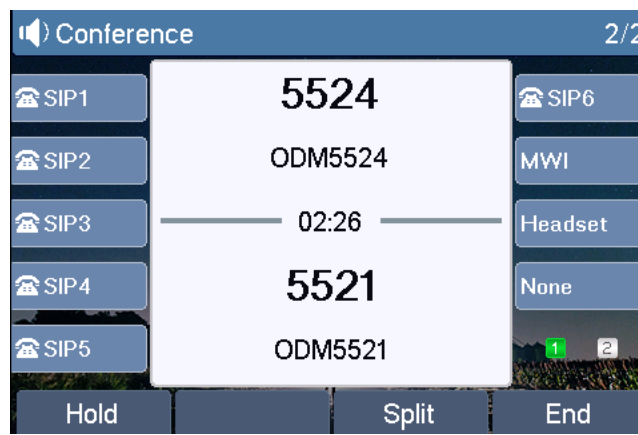

Figure 41 - Conference Call

6.1.3 Call Transfer

When the user is talking with a remote party and wish to transfer the call to another remote party, there are two way to transfer the call, attended and unattended.

■ Attended Transfer

The attended call transfer is also known as the 'polite mode' which is to dial through the other remote party, wait for the remote party to answer the call and then transfer the call.

This is the same procedure as making two concurrent calls. In the dual call mode, press the [XFER] button to transfer the first party to the second one.

■ Unattended / Blind Transfer

Unattended transfer is also known as 'Fire and Forget' mode. Instead of connecting to the second party first and confirming the second call is established, user press [XFER] button first then dial the second party number. When the number is dialed, user can press[XFER] button again and the first party will be transfer to the second.

This is like helping the first party to dial to the second one. However, the transfer could be successful if the second party answered it, or could be failed if the second party is busy or rejected it.

NOTICE! More advanced transfer configuration, please refer to 8.14 LINES / Dial Plan.

6.2 Using Phonebook

User can save contacts' information in the phonebook and dial the contact's phone number(s) from the phonebook. To open the phonebook, user can press soft-menu button [Dir] in the default standby screen or keypad.

By default the phonebook is empty, user may add contact(s) into the phonebook manually or from call logs.

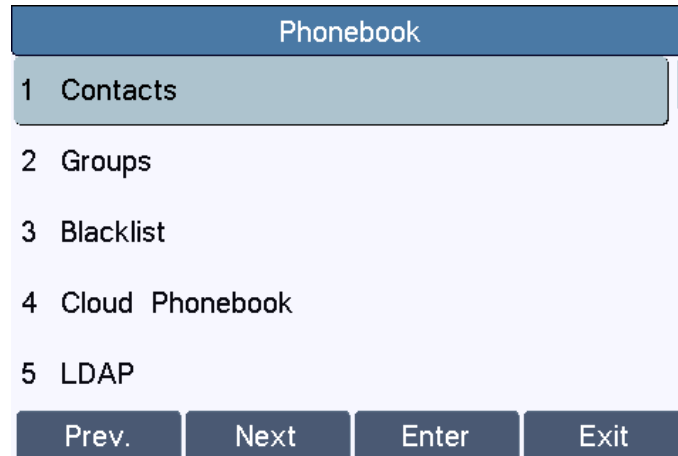

Figure 42 - Phonebook screen

NOTICE! The device can save up to total 500 contact records.



Figure 43 - Phonebook is Empty

When there are contact records in the phonebook, the contact records will be arranged in the alphabet order. User may browse the contacts with up/down navigation keys. User may fast scroll the contact list by holding the up/down navigation keys. The record indicator tells user which contact is currently focused. User may check the contact's information by pressing [OK] button.

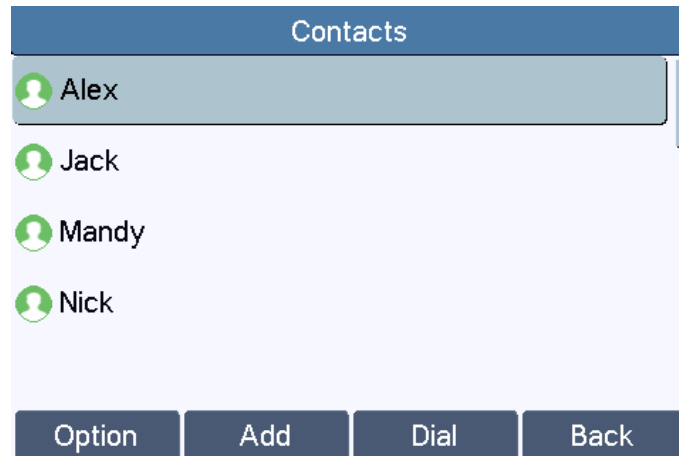

Figure 44 - Browsing Phonebook

6.2.1 Add / Edit / Delete Contact

To add a new contact, user should press [Add] button to open Add Contact screen and enter the contact information of the followings.

- Contact Name
- Tel. Number
- Mobile Number
- Other Number
- Ring Tone
- Contact Group

Contacts			
Name	Hugo		
Tel	4567_		
Mobile			
Other			
Ring	Default		
Delete	123	Save	Back

Figure 45 - Add New Contact

User can edit a contact by pressing [Option] -> [Edit] button.

To delete a contact, user should move the record indicator to the position of the contact to be deleted, press [Option] -> [Delete] button and confirm with [Yes].

6.2.2 Add / Edit / Delete Group

User can open the group list by pressing [Groups] button in phonebook screen.

By default, the group list is blank. User can create his/her own groups, edit the group name, add or remove contacts in the group, and delete a group.

To add a group, press [Add] button.

To delete a group, press [Option] -> [Delete] button.

To edit a group, press [Edit] button.

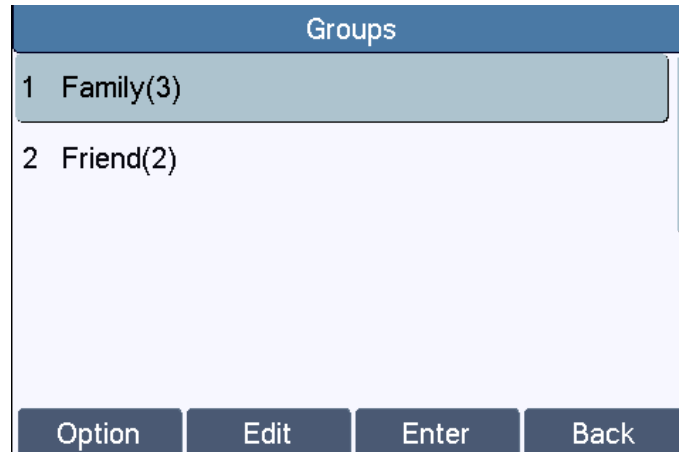

Figure 46 - Group List

6.2.3 Browse and Add / Remove Contacts in Group

User can browse contacts in a group by opening the group in group list with [OK] button.

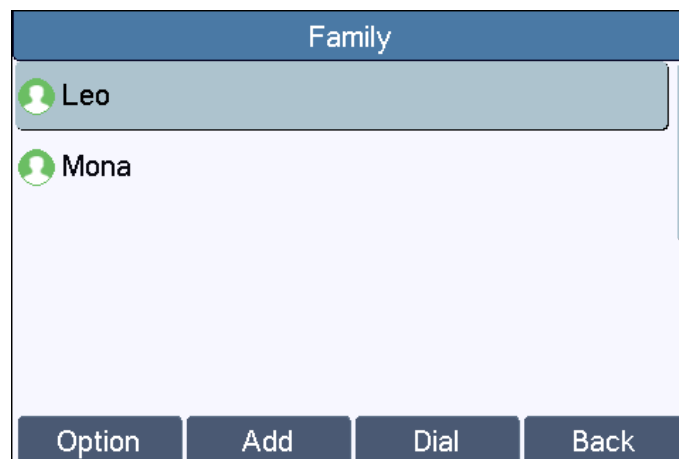

Figure 47 - Browsing Contacts in a Group

When user is browsing contacts of a group, user can also add or remove contacts in that group by pressing [Add] button to enter the group contacts management screen. Press [Add] button to create a new contact for the group; press [Option] button to remove the contact from the group.



Figure 48 - Add/Remove Contacts in a Group

6.3 Using Cloud Phonebook

Cloud phonebook allows user to configure the device to download a phonebook from a cloud server. This is very useful for office users to use the phonebook from a single source and save the effort to create and maintain the contact list individually. It is also a useful tool for user to synchronize his/her phonebook from a personal mobile phone to the device with Cloud Phonebook Service and App which is to be provided publicly soon.

NOTICE! The cloud phonebook is ONLY temporarily downloaded to the device each time it is opened on the device to ensure the user get the most up to date phonebook. However, the downloading may take a couple seconds depending on the network condition. Therefore, it is highly recommended to the users to save important contacts from cloud to local phonebook to save the time of waiting for downloading.

To open cloud phonebook list, press [Cloud Phonebook] in phonebook screen.

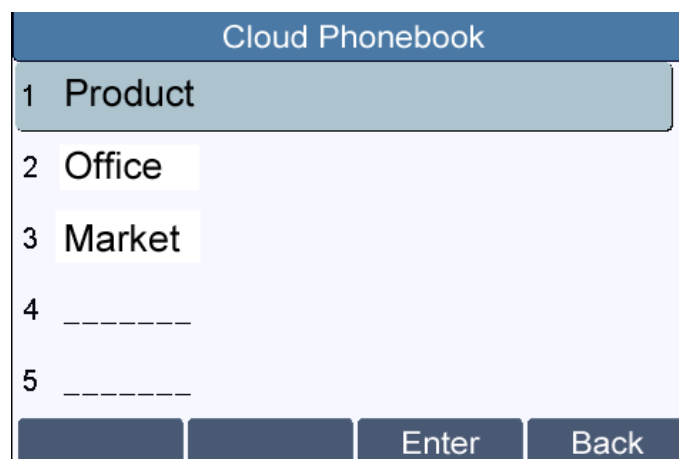

Figure 49 - Cloud Phonebook List

6.3.1 Open Cloud Phonebook

In cloud phonebook screen, user can open a cloud phonebook by pressing [OK] / [Enter] button. The device will start downloading the phonebook. If downloading failed, user will be prompted with a warning message. Once the cloud phonebook is downloaded completed, user may browse the contact list and dial the contact number same as in local phonebook.

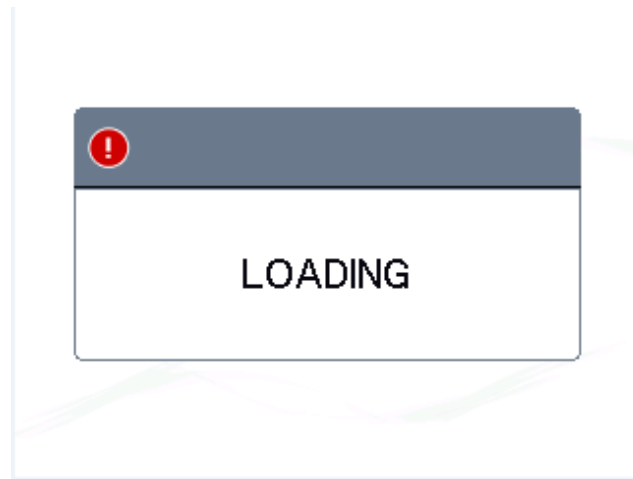

Figure 50 - Downloading Cloud Phonebook

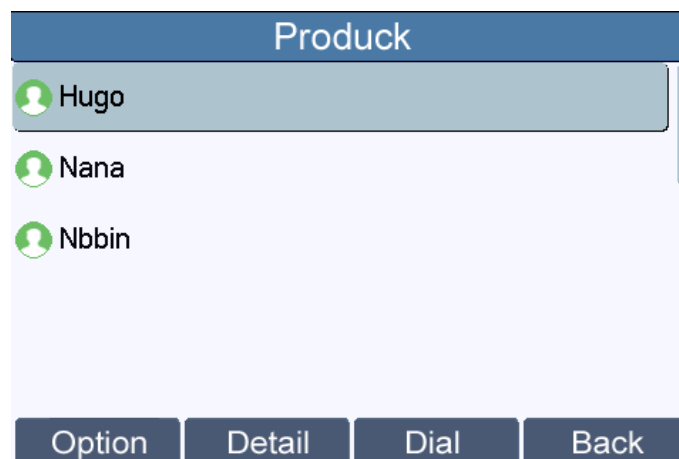

Figure 51 - Browsing Contacts in Cloud Phonebook

6.4 Call Logs

The device can store up to 600 call log records and user can open the call logs to check all incoming, outgoing, and missed call records by pressing soft-menu button [History]

In the call logs screen, user may browse the call logs with up/down navigation keys.

Each call log record is presented with 'call type' and 'call party number / name'. User can check further call log detail by pressing [OK] button and dial the number with [Dial] button, or add the call log number to phonebook with pressing [Option] -> [Add to Contact] .

User can delete a call log by pressing [Delete] button and can clear all call logs by pressing [Clear] button.

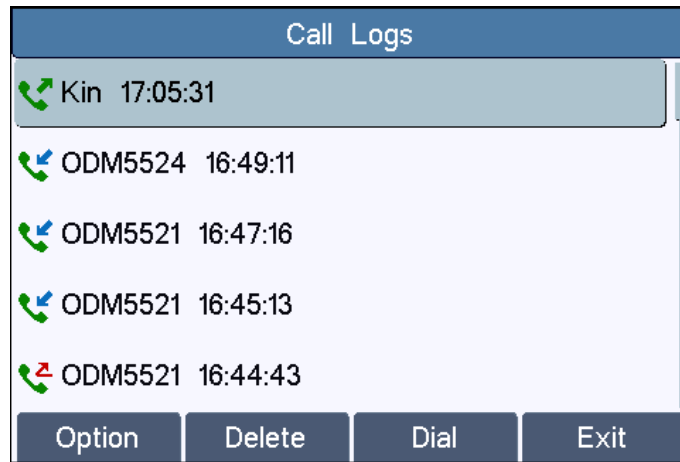





Figure 52 - Call Logs

User can also filter call logs with specific call log type to narrow down the call log records by pressing the left/right navigation button and select one of the call log types in the soft-menu buttons.

-  - Missed Calls
-  - Received Calls / Incoming Calls
-  - Dial Calls / Outgoing Calls

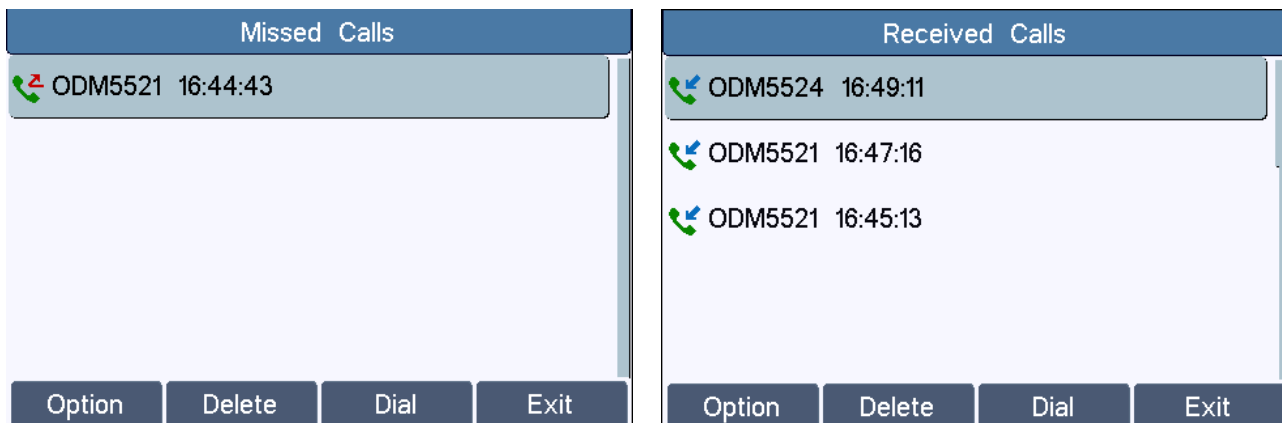

Figure 53 - Filter Call Log Type

6.5 Voice Message

If the service of the lines supports voice message feature, when the user is not available to answer the call, the caller can leave a voice message on the server to the user. User will receive voice message notification from the server and device will prompt a voice message waiting icon on the standby screen.

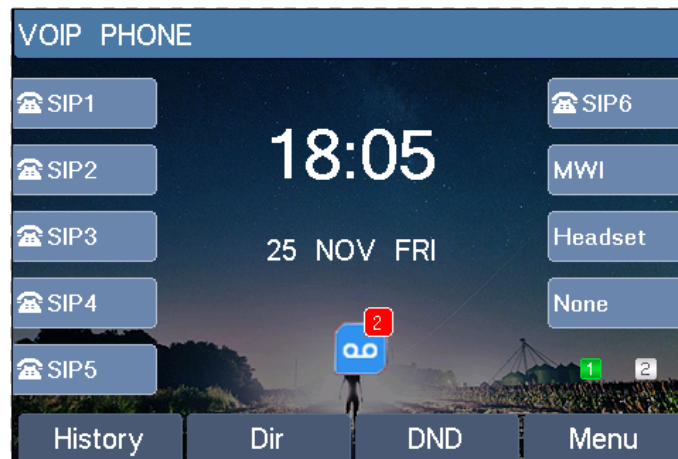

Figure 54 - New Voice Message Notification

To retrieve the voice messages, user must configure the voice message number first. Once the voice message number is configured, user can retrieve the voice message of a line by pressing the [Dial] button in the voice message screen.

When the device is in the default standby mode.

- Press the [MWI] button when you configured MWI DSS key. (You can also press [Menu] / [Applications] / [Voice Message] to enter MWI interface)
- When you opened voice message configuration interface, select the line to be configured with up/down navigation keys.
- Press [Edit] button to enable and edit the voice message number, when done, press [OK] / [Save] button to save the configuration.

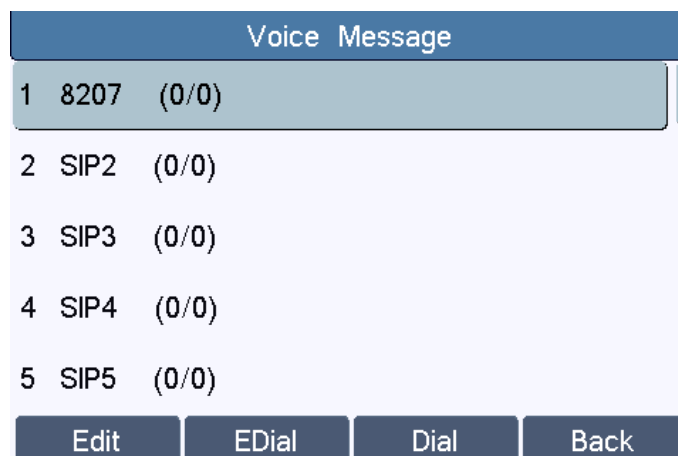

Figure 55 - Voice Message Screen

8207			
Mode	Enabled		
Tel	9999_		
Delete	123	Save	Back

Figure 56 - Configure the Voice Message Number

6.6 Do-Not-Disturb

User may enable Do-Not-Disturb (DND) feature on the device to reject incoming calls (including call waiting). The DND can be enabled on line basis.

To quickly enable or disable the DND on all lines.

When the device is in the default standby mode.



- Press [DND] button to enable DND on all line and icon  will be displayed on the screen.
- Press [DND] button again to disable DND on all line and icon  will be disappeared.



Figure 57 - DND Enabled on All Lines

If user wishes to enable or disable DND on a specific line, user could change the DND mode in DND configurations.

- Press soft-button [Menu] till you find the [Features] item.
- Enter [Features] item till you find the [DND] item.
- Enter [DND] item till you find [DND item].
- Press left/right navigation key to change the DND mode or DND state on specific line. When done, press [Save] button to save the changes.
- User will see icon  'Do Not Disturb' against the enabled line.

DND	
Mode	Line
Line1	Enabled 
Line2	Disabled
Line3	Disabled
Line4	Disabled
<div style="display: flex; justify-content: space-between;"> Save Back </div>	

Figure 58 - Configure DND on Line

6.7 Auto-Answering

User may enable auto-answering feature on the device and any incoming call will be automatically answered (not including call waiting). The auto-answering can be enabled on line basis.

When the device is in the default standby mode, if user wishes to enable or disable auto-answering on a specific line or change the auto-answering delay time, user could change the auto-answering configuration adopt following steps.

- Press soft-button [Menu] till you find the [Features] item.
- Enter [Features] item till you find the [Auto Answer] item.
- Enter [Auto Answer] item to change the auto-answering configuration on a specific line
- Press left/right navigation button to select the auto-answering option. When done, press [Save] button to save the changes.
- The default auto-answering delay is 5 seconds.

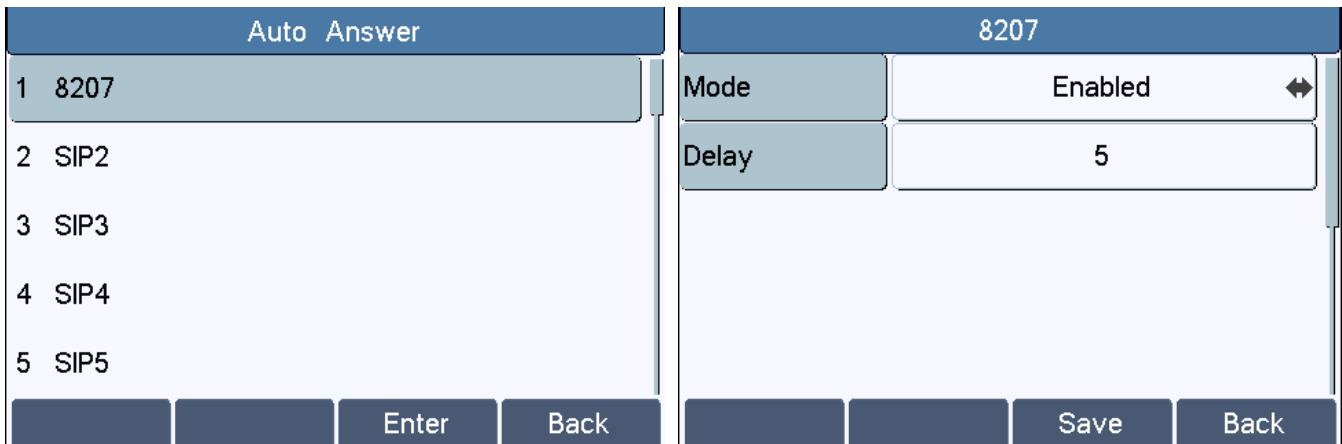

Figure 59 - Configure Auto-answering on Line1



Figure 60 - Auto-answering Enabled on Line1

6.8 Call Forward

Call forward is also known as 'Call Divert' which is to divert the incoming call to a specific number based on the conditions and configurations. User can configure the call forward settings of each line.

There are three types.

- **Unconditional Call Forward** – Forward any incoming call to the configured number.
- **Call Forward on Busy** – When user is busy, the incoming call will be forwarded to the configured number.
- **Call Forward on No Answer** – When user does not answer the incoming call after the configured delay time, the incoming call will be forwarded to the configured number.

To configure call forward, when the device is in the default standby mode,

- Press soft-button [Menu] till you find the [Features] item.
- Enter [Features] item till you find the [Call Forward] item.
- Press [Call Forward] button to open call forward configuration screen, select the line to be configured with up/down navigation keys.
- Press [Enter] button to edit the call forward settings.
- Select the call forward type with up/down navigation keys. Click [Enter] button to configure the call forward number and delay time, if applicable.
- Enable or Disable call forward with left/right navigation buttons against specific lines and types.
- If select 'Enable', browse the setting parameters with up/down navigation keys and enter required information. When done, press [Save] / [OK] button to save the changes.



Figure 61 - Select Line for Call Forward Configuration

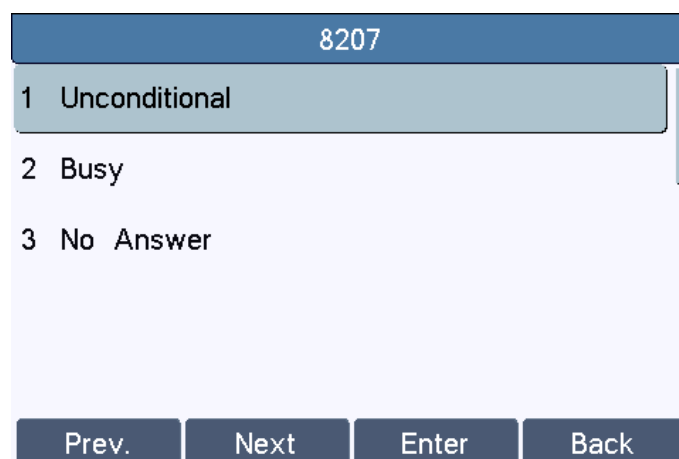

Figure 62 - Select Call Forward Type

Unconditional	
Mode	Enabled ↔
Tel	35
<div style="display: flex; justify-content: space-between;"> Save Back </div>	

Figure 63 - Activate Call Forward and configure Call Forward Number

No Answer	
Mode	Enabled
Tel	355
Time	5
<div style="display: flex; justify-content: space-between;"> Delete 123 Save Back </div>	

Figure 64 - Set Delay Time for Call Forward on No Answer

6.9 DSS LCD Configuration

There are 7 DSS keys corresponded to the LCD display to provide dynamic Line/DSS/BLF functions up to four pages at virtualized total 30 DSS keys. User may configure/customize each DSS key in each page. User can enter the DSS Key page configuration by long-press DSS page key, where user can Delete/Add page(s) for the DSS LCD. Besides, user can modify DDS key configuration by long-press each one.

Page Setting	
Page Number	Page 2 ↔
<div style="display: flex; justify-content: space-between;"> Add Delete Exit </div>	

Figure 65 - DSS Page Configuration Screen

The phone provide DSS key configuration, such as.

Memory Key

- Speed Dial/Intercom/BLF/Presence/Call Park/Call Forward(For someone)
- ◆ Line
- ◆ Key Event
 - MWI/DND/Hold/Transfer/Phonebook/Redial/Pickup/Call Forward(for entitle line)
- ◆ DTMF
- ◆ URL
- ◆ BLF List Key
- ◆ Multicast

BLF/Intercom/Speed Dial number can match contact intelligently as the label, which is stored in phonebook, and DSS LCD will display the contact name rather than extension number. Moreover, user also can add the user-defined title for the DSS Keys, which is configured as Memory Key / Line / URL / Multicast .

NOTICE! User-defined title is limited to 15 characters at most.

More detailed information *refers to* **8.26 FUNCTION KEY / Function Key** and **Table 13 - Look-up Table of Characters**.



Figure 66 - DSS Key Page Configuration

7 Phone Settings

7.1 Adjust Audio Volume

When the device is in the default standby mode,

- Press soft-button [Menu] till you find the [Settings] item.
- Enter [Settings] item till you find the [Basic Settings] item.
- Enter [Basic Settings] item till you find [Voice Volume] item.
- Enter [Voice Volume] item and you will find [Handset Volume],[Handsfree Volume] and [Headset Volume] item.
- Enter [Handset Volume] or [Handsfree Volume] or [Headset Volume] item, press Left / Right navigation keys to adjust the audio volume for different mode.
- Save the adjustment by pressing [OK] or [Save] when done.

7.2 Set Ring Tone Volume and Type

When the device is in the default standby mode,

- Press soft-button [Menu] till you find the [Settings] item.
- Enter [Settings] item till you find the [Basic Settings] item.
- Enter [Basic Settings] item till you find [Ring Settings] item.
- Enter [Ring Settings] item and you will find [Ring Volume] and [Ring Type] item.
 - Enter [Ring Volume] item and you find [Headset Volume] and [Handsfree Volume] item.
 - ◆ Enter [Headset Volume] or [Handsfree Volume] item, press left / right navigation keys to adjust the ring volume.
 - ◆ Save the adjustment by pressing [OK] when done.
 - Enter [Ring Type] item, press left / right navigation keys to change the ring type.
 - ◆ Save the adjustment by pressing [OK] when done.

7.3 Adjust LCD Energy saving

When the device is in the default standby mode.

- Press soft-button [Menu] till you find the [Settings] item.
- Enter [Settings] item till you find the [Basic Settings] item.
- Enter [Basic Settings] item till you find [Screen Settings] item.
- Enter [Screen Settings] item till you find [Energysaving] item.
- Enter [Energysaving] item, press Left / Right navigation keys to adjust the LCD Energysaving mode.
- If select 'Enabled', browse the setting parameters with up/down navigation keys and enter required information. When done, press [Save] / [OK] button to save the changes.
- The default Energysaving time is 30 seconds.

7.4 Set Device Time/Date

When the device is in the default standby mode,

- Press soft-button [Menu] till you find the [Settings] item.
- Enter [Settings] item till you find the [Basic Settings] item.
- Enter [Basic Settings] item till you find [Time & Date] item.
- Enter [Time & Date] item, use up/down navigation keys to edit the time/date parameters and save the settings by pressing [OK] or [Save] when done.

Table 1 - Time Settings Parameters

Parameters	Description
Mode	Auto/Manual Auto: Enable network time synchronization via SNTP protocol, default enabled. Manual: User can modify data manually.
SNTP Server	SNTP server address
Time zone	Select the time zone
Daylight Saving Time	Enable or Disable the Daylight Saving Time
12-Hour Clock	Display the clock in 12-hour format
Time format	Select time format from one of the followings: <ul style="list-style-type: none"> ■ 1 JAN, MON ■ 1 January, Monday ■ JAN 1, MON ■ January 1, Monday ■ MON, 1 JAN ■ Monday, 1 January ■ MON, JAN 1 ■ Monday, January 1 ■ DD-MM-YY ■ DD-MM-YYYY ■ MM-DD-YY ■ MM-DD-YYYY ■ YY-MM-DD ■ YYYY-MM-DD
Date(Only Mode=Manual)	Edit the date of the device in the format of yyyy/mm/dd.
Time(Only Mode=Manual)	Edit the time of the device in the format of hh:mm:ss. Hh=00~23, mm=00~59, ss=00~59

7.5 Set Device Language

When the device is in the default standby mode.

- Press soft-button [Menu] till you find the [Settings] item.
- Enter [Settings] item till you find the [Basic Settings] item.
- Enter [Basic Settings] item till you find [Language] item.
- User can change the language by using the navigation keys.

7.6 Reboot the Device

When the device is in the default standby mode,

- Press soft-button [Menu] till you find the [Reboot System] item.
- Press [OK] or [Enter] button, a warning message “Reboot Now?” will be prompt to user.
- Press [Yes] or [OK] button to execute the reset command, or [No] to exit.

7.7 Reset to Factory Default

When the device is in the default standby mode,

- Press soft-button [Menu] till you find the [Settings] item, and press [OK] or [Enter] button.
- Enter [Advanced Settings] item, then input the device PIN (Default PIN is 123) to enter the interface.
- Enter [Reset to Default] item, then a warning message “Factory Reset, Continues?” will be prompt to user.
- Press [Yes] or [OK] button to execute the reset command, or [No] to exit.

8 Web Portal

8.1 Web Portal Authentication

User can log in onto the device web portal to manage the device or user's profile. User must provide correct username and password to be able to log in.

8.2 Web Call

Besides making and receiving phone calls by operating the device directly, user could also making and receiving phone calls by operating the controls in the web portal.

The web call is particularly suitable for users who use headphone. User can dial out a number by click the [Dial] button on top of the title of the web portal page, or click a contact in the phonebook, or click a number in the call logs, to make phone call and press [Answer] button to answer incoming call. When call ended, user can click [Hang up] button to end the call. All these operation can be done from the web portal without touching the phone.

NOTICE! The web call is limited to make a single call. To make or answer a second call is not allowed.

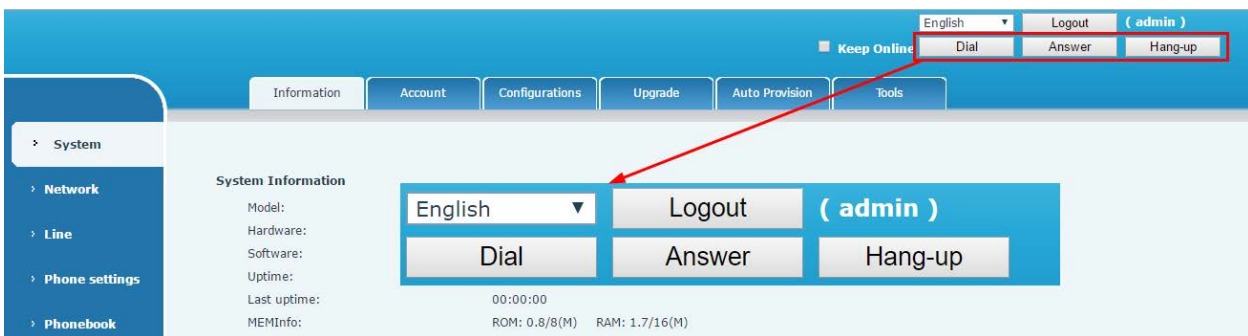

Figure 67 - Web Call Controls

Dial

Number:

L1
 L2
 L3
 L4

Figure 68 - Web Call, Entering Number and Select Line

8.3 SYSTEM / Information

User can get the system information of the device in this page including.

- Model
- Hardware Version
- Software Version
- Uptime
- Last uptime
- MEMInfo

And also summarization of network status,

- Network Mode
- MAC
- IP
- Subnet Mask
- Default Gateway

Besides, summarization of SIP account status,

- SIP User
- SIP account status (Registered / Unapplied / Trying / Timeout)

8.4 SYSTEM / Account

User may change his/her web authentication password in this page.

For users with Administrators privilege, the user can also manage user accounts by adding or deleting user account and assign privilege and password to new account.

There are two types of user privilege, Administrators and Users. If a user account is created as Users privilege, this account will have limited accessibility to the device and cannot change some device settings.

The user account can be used to operate the device or access the device web portal by login to the device or its web. User should log in to device web portal with his/her username and web password.

NOTICE! The device is shipped with a default Administrators user account. The username and password for the default account is 'admin' which has been printed on the brand and model label at the bottom side of the device.

8.5 SYSTEM / Configurations

Users with administrators privilege can export or import the device configuration in this page and reset the device to factory default.

8.6 SYSTEM / Upgrade

The device supports online upgrade by periodically checking the software release version on the cloud server. Meanwhile, user can download the software and upgrade the device manually when there is trouble for the device to connect to the cloud server.

8.7 SYSTEM / Auto Provision

The Auto Provision settings help IT manager or service provider to easily deploy and manage the devices in mass volume.

8.8 SYSTEM / Tools

Tools provided in this page help users to identify issues at trouble shooting. Please refer to **10 Trouble Shooting** for more detail.

Besides, the device also provided the screenshot feature to user.(LCD Page)

8.9 NETWORK / Basic

User can configure the network connection type and parameters in this page.

8.10 NETWORK / Advanced

The network advanced settings is often configured by IT manager to enhance the quality of service of the device.

8.11 NETWORK / VPN

User may configure a VPN connection in this page. Please refer to **9.1 VPN** for more detail.

8.12 LINES / SIP

The service of the line is configured in this page, choose the sip line to configured (SIP 1 – SIP 4). Click the dropdown arrow to adjust configuration accounting on each line.

Parameters	Description
Basic Settings	
Line Status	Display the current line status at page loading. To get the up to date line status, user has to refresh the page manually.
Username	Enter the username of the service account.
Display Name	Enter the display name to be sent in a call request.
Authentication Name	Enter the authentication name of the service account
Authentication Password	Enter the authentication password of the service account
SIP Proxy Server Address	Enter the IP or FQDN address of the SIP proxy server
SIP Proxy Server Port	Enter the SIP proxy server port, default is 5060
Outbound Proxy Address	Enter the IP or FQDN address of outbound proxy server provided by the service provider
Outbound Proxy Port	Enter the outbound proxy port, default is 5060
Realm	Enter the SIP domain if requested by the service provider
Activate	Whether the service of the line should be activated
Codec Settings	Set the priority and availability of the codecs by adding or remove them from the list.
Advanced Settings	
Call Forward Unconditional	Enable unconditional call forward, all incoming calls will be forwarded to the number specified in the next field
Call Forward Number for Unconditional	Set the number of unconditional call forward
Call Forward on Busy	Enable call forward on busy, when the phone is busy, any incoming call will be forwarded to the number specified in the next field
Call Forward Number for Busy	Set the number of call forward on busy
Call Forward on No Answer	Enable call forward on no answer, when an incoming call is not answered within the configured delay time, the call will be forwarded to the number specified in the next field
Call Forward Number for No Answer	Set the number of call forward on no answer
Call Forward Delay for No Answer	Set the delay time of not answered call before being forwarded
Enable Hotline	Enable hotline configuration, the device will dial to the specific number immediately at audio channel opened by off-hook handset or turn on hands-free speaker or headphone
Hotline Number	Set the hotline dialing number
Hotline Delay	Set the delay for hotline before the system automatically dialed it
Enable Auto Answering	Enable auto-answering, the incoming calls will be answered

	automatically after the delay time
Auto Answering Delay	Set the delay for incoming call before the system automatically answered it
Subscribe For Voice Message	Enable the device to subscribe a voice message waiting notification, if enabled, the device will receive notification from the server if there is voice message waiting on the server
Voice Message Number	Set the number for retrieving voice message
Voice Message Subscribe Period	Set the interval of voice message notification subscription
Enable DND	Enable Do-not-disturb, any incoming call to this line will be rejected automatically
Blocking Anonymous Call	Reject any incoming call without presenting caller ID
Use 182 Response for Call waiting	Set the device to use 182 response code at call waiting response
Anonymous Call Standard	Set the standard to be used for anonymous
Dial Without Registered	Set call out by proxy without registration
User Agent	Set the user agent, the default is Model with Software Version.
Use Quote in Display Name	Whether to add quote in display name
Ring Type	Set the ring tone type for the line
Conference Type	Set the type of call conference, Local=set up call conference by the device itself, maximum supports two remote parties, Server=set up call conference by dialing to a conference room on the server
Server Conference Number	Set the conference room number when conference type is set to be Server
Transfer Timeout	Set the timeout of call transfer process
Enable Long Contact	Allow more parameters in contact field per RFC 3840
Enable Missed Call Log	If enabled, the phone will save missed calls into the call history record.
Response Single Codec	If setting enabled, the device will use single codec in response to an incoming call request
Use Feature Code	When this setting is enabled, the features in this section will not be handled by the device itself but by the server instead. In order to control the enabling of the features, the device will send feature code to the server by dialing the number specified in each feature code field.
Enable DND	Set the feature code to dial to the server
Disable DND	Set the feature code to dial to the server
Enable Call Forward Unconditional	Set the feature code to dial to the server

Disable Call Forward Unconditional	Set the feature code to dial to the server
Enable Call Forward on Busy	Set the feature code to dial to the server
Disable Call Forward on Busy	Set the feature code to dial to the server
Enable Call Forward on No Answer	Set the feature code to dial to the server
Disable Call Forward on No Answer	Set the feature code to dial to the server
Enable Blocking Anonymous Call	Set the feature code to dial to the server
Disable Blocking Anonymous Call	Set the feature code to dial to the server
Specific Server Type	Set the line to collaborate with specific server type.
Registration Expiration	Set the SIP expiration interval
Use VPN	Set the line to use VPN restrict route
Use STUN	Set the line to use STUN for NAT traversal
Convert URI	Convert digit and alphabet characters to %hh hex code
DTMF Type	Set the DTMF type to be used for the line
DTMF SIP INFO Mode	Set the SIP INFO mode to send '*' and '#' or '10' and '11'
Transport Protocol	Set the line to use TCP or UDP for SIP transmission
SIP Version	Set the SIP version
Caller ID Header	Set the Caller ID Header
Enable Strict Proxy	Enables the use of strict routing. When the phone receives packets from the server, it will use the source IP address, not the address in via field.
Enable user=phone	Sets user=phone in SIP messages.
Enable SCA	Enable/Disable SCA (Shared Call Appearance)
Enable BLF List	Enable/Disable BLF List
Enable DNS SRV	Set the line to use DNS SRV which will resolve the FQDN in proxy server into a service list
Keep Alive Type	Set the line to use dummy UDP or SIP OPTION packet to keep NAT pinhole opened
Keep Alive Interval	Set the keep alive packet transmitting interval
Sync Clock Time	Time Syncn with server
Enable Session Timer	Set the line to enable call ending by session timer refreshment. The call session will be ended if there is not new session timer event update received after the timeout period
Session Timeout	Set the session timer timeout period
Enable Rport	Set the line to add rport in SIP headers
Enable PRACK	Set the line to support PRACK SIP message
Keep Authentication	Keep the authentication parameters from previous

	authentication
Auto TCP	Using TCP protocol to guarantee usability of transport for SIP messages above 1500 bytes
Enable Feature Sync	Feature Sync with server
Enable GRUU	Support Globally Routable User-Agent URI (GRUU)
BLF Server	The registered server will receive the subscription package from ordinary application of BLF phone. Please enter the BLF server, if the sever does not support subscription package, the registered server and subscription server will be separated.
BLF List Number	BLF List allows one BLF key to monitor the status of a group. Multiple BLF lists are supported.
SIP Encryption	Enable SIP encryption such that SIP transmission will be encrypted
SIP Encryption Key	Set the pass phrase for SIP encryption
RTP Encryption	Enable RTP encryption such that RTP transmission will be encrypted
RTP Encryption Key	Set the pass phrase for RTP encryption

8.13 LINES / Dial Peer

This functionality offers you more flexible dial rule, you can refer to the following content to know how to use this dial rule.

Table 3 - Dial Peer Settings for Lines on Web

Parameters	Description
Phone number	There are two types of matching: Full Matching or Prefix Matching. In Full matching, the entire phone number is entered and then mapped per the Dial Peer rules. In prefix matching, only part of the number is entered followed by T. The mapping with then take place whenever these digits are dialed. Prefix mode supports a maximum of 30 digits.
<p>Note: Two different special characters are used.</p> <ul style="list-style-type: none"> ■ x -- Matches any single digit that is dialed. ■ [] -- Specifies a range of numbers to be matched. It may be a range, a list of ranges separated by commas, or a list of digits. 	
Destination	Set Destination address. This is for IP direct.
Port	Set the Signal port, and the default is 5060 for SIP.
Alias	Set the Alias. This is the text to be added, replaced or deleted. It is an optional item.

Note: There are four types of aliases.

- all: xxx – xxx will replace the phone number.
- add: xxx – xxx will be dialed before any phone number.
- del –The characters will be deleted from the phone number.
- rep: xxx – xxx will be substituted for the specified characters.

Suffix	Characters to be added at the end of the phone number. It is an optional item.
Delete Length	Set the number of characters to be deleted. For example, if this is set to 3, the phone will delete the first 3 digits of the phone number. It is an optional item.

Examples of different alias application

This feature allows the user to create rules to make dialing easier. There are several different options for dial rules. The examples below will show how it works.

Example 1: Global Substitution

It seems like a shortcut to dial out. When user dial “32”, the dialed number will be replaced of “833333”. But if user dials “322”, the device will still send “322” rather than “8333332”. The replacement rules should be matched globally.

Add Dial Peer

Phone Number: 32

Destination(Optional): 255.255.255.255

Port(Optional):

Alias(Optional): all:833333

Call Mode: SIP

Suffix(Optional):

Deleted Length(Optional):

Apply

Figure 69 - Global Substitution Configuration

Example 2: Local Substitution

To dial a long distance call to Beijing requires dialing area code 010 before the local phone number. Using this feature 1 can be substituted for 010. For example, to call 62213123 would only require dialing 162213123 instead of 01062213123.

Add Dial Peer

Phone Number	<input type="text" value="1T"/>
Destination(Optional)	<input type="text"/>
Port(Optional)	<input type="text"/>
Alias(Optional)	<input type="text" value="rep:010"/>
Call Mode	<input type="text" value="SIP"/>
Suffix(Optional)	<input type="text"/>
Deleted Length(Optional)	<input type="text" value="1"/>

Figure 70 - Local Substitution Configuration

Example 3: Add Prefixes

If the dialed number starts with the fixed prefix number, the phone will send out your dialed phone number adding prefix number automatically.

For example, when users dial “9312”, the device will send out “0079312”.

Add Dial Peer

Phone Number	<input type="text" value="9T"/>
Destination(Optional)	<input type="text"/>
Port(Optional)	<input type="text"/>
Alias(Optional)	<input type="text" value="add:007"/>
Call Mode	<input type="text" value="SIP"/>
Suffix(Optional)	<input type="text"/>
Deleted Length(Optional)	<input type="text"/>

Figure 71 - Add Prefixes Configuration

Example 4: Add Suffixes

If the dialed number ends with the fixed suffix number, the phone will send out your dialed phone number adding suffix number automatically.

For example, when users dial "1383322", the device will send out "13833220088" .

The screenshot shows the 'Add Dial Peer' configuration form with the following fields and values:

Phone Number	138T
Destination(Optional)	
Port(Optional)	
Alias(Optional)	
Call Mode	SIP ▼
Suffix(Optional)	0088
Deleted Length(Optional)	

An 'Apply' button is located at the bottom right of the form.

Figure 72 - Add Suffixes Configuration

Example 5: Deletion

If the dialed number ends with the fixed prefix number, the phone will send out your dialed phone number deleting prefix number automatically.

For example, when users dial "98322", the device will send out "8322" .

The screenshot shows the 'Add Dial Peer' configuration form with the following fields and values:

Phone Number	9T
Destination(Optional)	255.255.255.255
Port(Optional)	
Alias(Optional)	del
Call Mode	SIP ▼
Suffix(Optional)	
Deleted Length(Optional)	1

An 'Apply' button is located at the bottom right of the form.

Figure 73 - Deletion Configuration

8.14 LINES / Dial Plan

Figure 74 - Dial Plan Configuration

The device supports 8 dialing modes:

- Press # to Send - Dial the desired number, and press # to send it to the server.
- Dial Fixed Length – Configure the fixed length to dial out
- Send after seconds – Number will be sent to the server after the specified time.
- Press # to Do Blind Transfer - Press # after entering the target number for the transfer. The phone will transfer the current call to the third party.
- Blind Transfer on Onhook - Hang up after entering the target number for the transfer. The phone will transfer the current call to the third party.
- Attended Transfer on Onhook - Hang up after the third party answers. The phone will transfer the current call to the third party.
- Attended Transfer on Conference Onhook - Hang up during a 3-way conference call, the other two ways will make a call.
- Press DSS Key to Do Blind Transfer – When user is in the 'XFER' screen, user can fulfill Blind Transfer by pressing DSS Key.

8.15 LINES / Basic Settings

Configure basic settings for lines.

Table 4 - Basic Settings for Lines on Web

Parameters	Description
SIP Settings	
Local SIP Port	Set the local SIP port used to send/receive SIP messages.
Registration Failure Retry Interval	Set the retry interval of SIP REGISTRATION when registration failed.
STUN Settings	

Server Address	Set the STUN server address
Server Port	Set the STUN server port, default is 3478
Binding Period	Set the STUN binding period which can be used to keep the NAT pinhole opened.
SIP Waiting Time	Set the timeout of STUN binding before sending SIP messages
TLS Certification File	Upload or delete the TLS certification file used for encrypted SIP transmission.

8.16 PHONE / Features

Configure the phone features

Table 5 - Common Phone Feature Settings on Web

Parameters	Description
DND Mode	Configure the Phone DND If enable Phone DND, the phone rejects any incoming call, the caller will automatically prompt hang up.
Ban Outgoing	If you select Ban Outgoing to enable it, and you cannot dial out any number.
Enable Call Waiting	Enable this setting to allow user to take second incoming call during an established call. Default enabled.
Enable Call Waiting Tone	Turn off this feature, and you will not hear a 'beep' sound in talking mode when there is another incoming call
Auto Hand up Delay	Specify Auto handdown time, the phone will hang up and return to the idle automatically after Auto Hand down time at hands-free mode, and play dial tone Auto handdown time at handset mode
Enable Call Completion	Enable Call Completion by selecting it, If the dialed line is busy, the sip server will inspect the dialed line status at intervals. If the dialed line is idle, the server will send notify message to inform the caller whether redial.
Hide DTMF	Configure the hide DTMF mode
Enable Pre-Dial	Disable this feature, user entering number will open audio channel automatically. Enable the feature, user enter the number without opening audio channel.
Enable Silent Mode	Enable Silent Mode by selecting it, the phone light will red blink to remind that there is a missed call instead of playing ring tone.
Disable Mute for Ring	Disable Mute for Ring
Enable Intercom	When intercom is enabled, the device will accept the incoming call request with a SIP header of Alert-Info instruction to automatically

	answer the call after specific delay.
Enable Intercom Mute	Enable mute mode during the intercom call
Enable Intercom Tone	If the incoming call is intercom call, the phone plays the intercom tone
Enable Intercom Barge	Enable Intercom Barge by selecting it, the phone auto answers the intercom call during a call. If the current call is intercom call, the phone will reject the second intercom call
Auto Answer By Headset	When this item is checked, the device will auto-answer phone calls by headset if the auto-answer or intercom is enabled.
Ring From Headset	Enable Ring From Handset by selecting it, the phone plays ring tone from handset.
Emergency Call Number	Configure the Emergency Call Number. Despite the keyboard is locked, you can dial the emergency call number
Enable Password Dial	Enable Password Dial by selecting it, When number entered is beginning with the password prefix, the following N numbers after the password prefix will be hidden as *, N stand for the value which you enter in the Password Length field. For example: you set the password prefix is 3, enter the Password Length is 2, then you enter the number 34567, it will display 3**67 on the phone.
Password Dial Prefix	Configure the prefix of the password call number
Enable Phone DND	Enable Phone DND
DND Response Code	Set the SIP response code on call rejection on DND
Busy Response Code	Set the SIP response code on line busy
Reject Response Code	Set the SIP response code on call rejection
Encryption Number Length	Configure the Encryption Number length
Restrict Active URI Source IP	Set the device to accept Active URI command from specific IP address.
Push XML Server	Configure the Push XML Server, when phone receives request, it will determine whether to display corresponding content on the phone which sent by the specified server or not.
Allow IP Call	If enabled, user can dial out with IP address
Enable Multi Line	Enable phone to make calls for 10 lines max, or disable for 2 lines max.
Enable Default Line	If enabled, user can assign default SIP line for dialing out rather than SIP1.
Enable Auto Switch Line	Enable phone to select an available SIP line as default automatically
Play Talking DTMF Tone	Play DTMF tone on the device when user pressed a phone digits during taking, default enabled.
Play Dialing DTMF Tone	Play DTMF tone on the device when user pressed a phone digits at dialing, default enabled.

Caller ID Display Priority	Change caller ID display priority. The default priority is "Phonebook" > "SIP Display Name" > "SIP URI". User may select one of the options to change the desired caller ID display priority.
Hotline Number	Set the Hot line Number
Hotline Delay	Set the Hot line Delay time.
Enable Silent Mode	Enable silent mode by selecting it, the phone incoming call indicator will blink to remind that there is a incoming call instead of playing ring tone.
Disable Mute for Ring	Disable mute for ring.

Action URL

URL for various actions performed by the phone. These actions are recorded and sent as xml files to the server. Sample format is <http://InternalServer/FileName.xml>

Restrict Outgoing Call

The user with Administrators privilege can set the rule to restrict some numbers from dialing out. This setting is device-wide and applies to every user of the device.

User can add restricted number by entering the number in the edit box and click "Add" button. To remove a number from the restriction list, select the number from the dropdown box and click "Delete" button to remove it.

8.17 PHONE / Audio

Change the audio settings.

Table 6 - Audio Settings on Web

Parameters	Description
First Codec	The first preferential DSP codec:G.711A/U,G.722,G.723,G.729,G.726-32, ILBC,AMR,AMR-WB
Second Codec	The second preferential DSP codec: G.711A/U,G.722,G.723,G.729,G.726-32, ILBC,AMR,AMR-WB,NONE
Third Codec	The third preferential DSP codec: G.711A/U,G.722,G.723,G.729,G.726-32 , ILBC,AMR,AMR-WB,NONE
Fourth Codec	The forth preferential DSP codec: G.711A/U,G.722,G.723,G.729,G.726-32 , ILBC,AMR,AMR-WB,NONE
Fifth Codec	The fifth preferential DSP codec:

	G.711A/U,G.722,G.723,G.729,G.726-32, ILBC,AMR,AMR-WB,NONE
Sixth Codec	The sixth preferential DSP codec: G.711A/U,G.722,G.723,G.729,G.726-32, ILBC,AMR,AMR-WB,NONE
Onhook Time	Configure the least reflection time of Hand down, the default is 200ms.
Tone Standard	Set the country standard of call progress tones, including dial tone, busy tone, ring-back tone, etc.
Handset Volume	Set the Handset volume, the value must be 1~9
Default Ring Type	Set the default ring type. If the caller ID of an incoming call was not configured with specific ring type, the default ring will be used.
Speakerphone Volume	Set the speakerphone volume, the value must be 1~9
Headset Ring Volume	Set the ring volume in the headset, the value must be 0~9
Headset Volume	Set the Headset volume, the value must be 1~9
Speakerphone Ring Volume	Set the ring volume in the speakerphone, the value must be 0~9
Headset Volume Offset	This is to adjust the base volume of the headset. Please note when set the volume at the maximum level it may create noise and decrease the echo canceller.
Headset Mic Offset	This is to adjust the base volume of the headset Mic.
G.729AB Payload Length	Set G729 Payload Length.
G.723.1 Bit Rate	5.3kb/s or 6.3kb/s is available
G.722 Timestamps	160/20ms or 320/20ms is available
DTMF Payload Type	Enter the DTMF payload type, the value must be 96~127.
Enable VAD	Enable Voice Activity Detection. When enabled, the device will suppress the audio transmission with artificial comfort noise signal to save the bandwidth.
Enable MWI Tone	The phone will play MWI tone when a new MWI Comes
EHS Type	Enable EHS Type by selecting it

8.18 PHONE / MCAST

This feature allows user to make some kind of broadcast call to people who are in multicast group. User can configure a multicast DSS Key on the phone, which allows user to send a Real Time Transport Protocol (RTP) stream to the pre-configured multicast address(es) without involving SIP signaling. You can also configure the phone to receive an RTP stream from pre-configured multicast listening address(es) without involving SIP signaling. You can specify up to 10 multicast listening addresses.

Table 7 - MCAST Parameters on Web

Parameters	Description
Normal Call Priority	Define the priority of the active call, 1 is the highest priority, 10 is the lowest.
Enable Page Priority	The voice call in progress shall take precedence over all incoming paging calls.
Name	Listened multicast server name
Host:port	Listened multicast server's multicast IP address and port.

8.19 PHONE / Time/Date

User can configure the device time settings in this page.

Table 8 - Time/Date Setting Parameters on Web

Parameters	Description
Network Time Server Settings	
Time Synchronized via SNTP	Enable time-sync through SNTP protocol
Time Synchronized via DHCP	Enable time-sync through DHCP protocol
Primary Time Server	Set primary time server address
Secondary Time Server	Set secondary time server address, when primary server is not reachable, the device will try to connect to secondary time server to get time synchronization.
Timezone	Select the time zone
Resync Period	Time of re-synchronization with time server
12-Hour Clock	Set the time display in 12-hour mode
Date Format	Select the time/date display format
Daylight Saving Time Settings	
Location	Select the user's time zone specific area
DST Set Type	Select automatic DST according to the preset rules of DST, or the manually input rules
Offset	The DST offset time
Month Start	The DST start month
Week Start	The DST start week
Weekday Start	The DST start weekday
Hour Start	The DST start hour
Minute Start	The DST start minute
Month End	The DST end month
Week End	The DST end week
Weekday End	The DST end weekday

Hour End	The DST end hour
Manual Time Settings	Set time manually

8.20 PHONE / Advanced

User can configure the advanced configuration settings in this page.

- Screen Configuration.
 - Enable Energysaving
 - Backlight Time
- LCD Menu Password Settings.
The password is 123 by default.
- Keyboard Lock Settings.
- Configure Greeting Words

The greeting message will display on the top left corner of the LCD when the device is idle, which is limited to 12 characters. The default chars are 'VOIP PHONE'.

8.21 PHONEBOOK / Contacts

User can add, delete, or edit contacts in the phonebook in this page. User can browse the phonebook and sorting it by name, phones, or filter them out by group.

To add a new contact, user should enter contact's information and press "Add" button to add it.

To edit a contact, click on the checkbox in front of the contact, the contact information will be copied to the contact edit boxes, press "Modify" button after finished editing.

To delete one or multiple contacts, check on the checkbox in front of the contacts wished to be deleted and click the "Delete" button, or click the "Clear" button with selecting any contacts to clear the phonebook.

User can also add multiple contacts into a group by selecting the group in the dropdown options in front of "Add to Group" button at the bottom of the contact list, selecting contacts with checkbox and click "Add to Group" to add selected contacts into the group.

8.22 PHONEBOOK / Cloud Phonebook

Cloud Phonebook

User may configure up to 8 cloud phonebooks. Each cloud phonebook must be configured with an URL where an XML phonebook is stored. The URL may be based on HTTP/HTTPs or FTP protocol with or without authentication. If authentication is required, user must configure the username and password.

To configure a cloud phonebook, the following information should be entered,

- Phonebook name (must)
- Phonebook URL (must)
- Access username (optional)
- Access password (optional)

LDAP Settings

The cloud phonebook allows user to retrieve contact list from a LDAP Server through LDAP protocols.

User must configure the LDAP Server information and Search Base to be able to use it on the device. If the LDAP server requests an authentication, user should also provide username and password.

To configure a LDAP phonebook, the following information should be entered,

- Display Title (must)
LDAP Server Address (must)
- LDAP Server Port (must)

Search Base (must)

- Access username (optional)
- Access password (optional)

8.23 PHONEBOOK / Blacklist

By adding a number into the blacklist, user will no longer receive phone call from that number and it will be rejected automatically by the device until user delete it from the blacklist.

User can add specific number to be blocked, or a prefix where any numbers matched the prefix will all be blocked.

8.24 PHONEBOOK / Advanced

User may export current phonebook in xml, csv, or vcf format file and save it locally on a computer.

User can also import contacts into phonebook from an xml, csv, or vcf file.

NOTICE! If user repeatedly imports a same phonebook, it will not create duplicated contacts in user's phonebook.

User can add new group in this page or delete an existing one. Deleting a contact group will not delete the contacts in that group.

8.25 CALL LOGS

User can browse complete call logs in this page, order the call logs by time, caller ID, contact name, duration, or line, and can also filter the call logs by the call log types, in, out, missed, or all.

User can save a call log into his/her phonebook or add it to the blacklist.

User can also make web call by click on the number of a call log.

8.26 FUNCTION KEY / Function Key

The device provides 28 user-define DSS Keys at most. User may configure/customize each DSS key in this webpage.

Table 9 - DSS Key Setting Parameters on Web

Parameters	Description
Memory Key	<p>BLF(NEW CALL/BXFE /AXFER): It is used to prompt user the state of the subscribe extension, and it can also pick up the subscribed number, which help user monitor the state of subscribe extension (idle, ringing, a call). There are 3 types for one-touch BLF transfer method. p.s. User should enter the pick-up number for specific BLF key to fulfill the pick-up operation.</p> <p>Presence: Compared to BLF, the Presence is also able to view whether the user is online. Note: You cannot subscribe the same number for BLF and Presence at the same time</p> <p>Speed Dial: You can call the number directly which you set. This feature is convenient for you to dial the number which you frequently dialed.</p> <p>Intercom: This feature allows the operator or the secretary to connect the phone quickly; it is widely used in office environments.</p> <p>MWI : You can set the speed dial key for the voice messages.</p> <p>Call Park: You can retrieve the held call by using the call park code.</p> <p>Call forward: You can transfer the call to the set number.</p>
Line	It can be configured as a Line Key. User is able to make a call by pressing Line Key.
Key Event	User can select a key event as a shortcut to trigger. For example: MWI / DND / Release / Headset / Hold / etc.
DTMF	It allows user to dial or edit dial number easily.
URL	Open the specific URL directly.
Multicast	Configure the multicast address and audio codec. User presses the key to initiate the multicast.
BLF List Key	You can view the subscription status of the subscribed numbers.
LDAP	You can store the phonebook via the LDAP function

8.27 FUNCTION KEY / EXT key

The device support 3 Extension module. User may configure/customize each DSS key in this webpage.

Expansion Module Selection

Expansion Module 1 ▾ Load Not Connected

Reset BLF Transfer Type Make a New Call ▾ Apply

Key	Type	Value	Line	Subtype	PickUp Number
F 1	None ▾		Auto ▾	None ▾	
F 2	None ▾		Auto ▾	None ▾	
F 3	None ▾		Auto ▾	None ▾	

Figure 75 - EXT key Configuration

8.28 FUNCTION KEY / Softkey

User can configure different functions in different screens for each softkey.

SoftKey Settings

Softkey Mode More ▾

Screen Call Dialer ▾

Unselected Softkeys Selected Softkeys

None
Call Back
Clear
In
Join
Missed
MWI
Next Line(Next)
Dialed
Pause
Phonebook(Dir)
Pickup
Prev Line(Prev.)
Redial
Remote XML(R-XML)

Delete
History
Dial
Exit

Apply

Figure 76 - Softkey Configuration

9 Advanced Features

9.1 VPN

Virtual Private Network (VPN) is a technology to allow device to create a tunneling connection to a server and becomes part of the server's network. The network transmission of the device may be routed through the VPN server.

For some users, especially enterprise users, a VPN connection might be required to be established before activate a line registration. The device supports two VPN modes, Layer 2 Transportation Protocol (L2TP) and OpenVPN.

The VPN connection must be configured and started (or stopped) from the device web portal.

9.1.1 L2TP

NOTICE! The device only supports non-encrypted basic authentication and non-encrypted data tunneling. For users who need data encryption, please use OpenVPN instead.

To establish a L2TP connection, users should log in to the device web portal, open page [Network] -> [VPN]. In VPN Mode, check the "Enable VPN" option and select "L2TP", then fill in the L2TP server address, Authentication Username, and Authentication Password in the L2TP section. Press "Apply" then the device will try to connect to the L2TP server.

When the VPN connection established, the VPN IP Address should be displayed in the VPN status. There may be some delay of the connection establishment. User may need to refresh the page to update the status.

Once the VPN is configured, the device will try to connect to the VPN automatically when the device boots up every time until user disable it. Sometimes, if the VPN connection does not established immediately, user may try to reboot the device and check if VPN connection established after reboot.

9.1.2 OpenVPN

To establish an OpenVPN connection, user should get the following authentication and configuration files from the OpenVPN hosting provider and name them as the following,

OpenVPN Configuration file: client.ovpn

CA Root Certification: ca.crt

Client Certification: client.crt

Client Key: client.key

User then upload these files to the device in the web page [Network] -> [VPN], Section OpenVPN Files. Then user should check "Enable VPN" and select "OpenVPN" in VPN Mode and click "Apply" to enable OpenVPN connection.

Same as L2TP connection, the connection will be established every time when system rebooted until user disable it manually.

10 Trouble Shooting

When the device does not work properly, users may try the following methods to recover the device or gather relative information and send an issue report to support.

10.1 Get Device System Information

Users may get the device system information by pressing [Settings] -> [Status]. The following basic information will be provided:

Mode

IP

Software Version

More...

User can select [More] item to get more information in detail.

10.2 Upgrade to the latest software

Manufacturer will keep publishing software update to fix bugs and improve device features. The device will check for new software release on manufacturer cloud server automatically and periodically.

10.3 Reboot Device

Users may reboot the device from soft-menu, [Menu] -> [Reboot System], and confirm the action by [Yes]. Or, simply remove the power supply and restore it again.

10.4 Reset Device to Factory Default

Reset Device to Factory Default will erase all user's configuration, preference, database and profiles on the device and restore the device back to the state as factory default.

To perform a factory default reset, user should [Menu] -> [Settings] -> [Advanced settings], and then input the password to enter the interface. Then choose [Reset to Default] and press [Enter], and confirm the action by [Yes]. The device will be rebooted into a clean factory default state.

10.5 Network Packets Capture

Sometimes it is helpful to dump the network packets of the device for issue identification. To get the packets dump of the device, user needs to log in the device web portal, open page [System] -> [Tools] and click [Start] in “Network Packets Capture” section. A pop-up message will be prompt to ask user to save the capture file. User then should perform relevant operations such as activate/deactivate line or making phone calls and click [STOP] button in the web page when operation finished. The network packets of the device during the period have been dumped to the saved file. User may examine the packets with a packet analyzer or send it to support.

10.6 Entering Post Mode and Recover System Image

WARNING! PLEASE AVOID UPDATING SYSTEM IMAGE FROM POST MODE UNLESS THE SYSTEM IMAGE IS DAMAGED.

If the device could not boot up and entered into POST MODE, it is usually because of system image damaged due to power failure during software upgrade. When this occurs, users may follow below steps to restore the system image.

Step 1. Download the latest device software.

Step 2. Setup a FTP server on a PC and put the downloaded software in the FTP repository. (Windows users can download free FTP server software such as WFTPD32 or 3CDaemon)

Step 3. Configure the PC with fixed IP address as 192.168.10.10

Step 4. Connect device network with the PC.





Step 5. Telnet from PC to device: >telnet 192.168.10.1

Step 6. When telnet connection established, it will run POST maintenance tools, please select ‘2’ – FTP update image, and fill in required information to start the image update.

Step 7. Once update finished, please select ‘4’ to reboot the device.

10.7 Common Trouble Cases

Table 10 - Trouble Cases

Trouble Case	Solution
Device could not boot up	<ol style="list-style-type: none"> 1. The device is powered by external power supply via power adapter or PoE switch. Please use standard power adapter provided or PoE switch met with the specification requirements and check if device is well connected to power source. 2. If you saw "POST MODE" on the device screen, the device system image has been damaged. Please refer to the instructions in "10.6 Entering Post Mode and Recover System Image" to restore the system image.
Device could not register to a service provider	<ol style="list-style-type: none"> 1. Please check if device is well connected to the network. The network Ethernet cable should be connected to the  [Network] port NOT the  [PC] port. If the cable is not well connected to the network icon  [WAN disconnected] will be flashing in the middle of the screen. 2. Please check if the device has an IP address. Check the system information, if the IP displays "Negotiating...", the device does not have an IP address. Please check if the network configurations is correct. 3. If network connection is fine, please check again your line configurations. If all configurations are correct, please kindly contact your service provider to get support, or follow the instructions in "10.6 Network Packet Capture" to get the network packet capture of registration process and send it to support to analyze the issue.
No Audio or Poor Audio in Handset	<ol style="list-style-type: none"> 1. Please check if Handset is connected to the correct Handset  port NOT Headphone  port. 2. The network bandwidth and delay may be not suitable for audio call at the moment.
Poor Audio or Low Volume in Headphone	<ol style="list-style-type: none"> 1. There are two Headphone wire sequence in the market. Please use the Headphone provided, or consult the wire sequence if you wish to use a third party headphone. 2. The network bandwidth and delay may be not suitable for audio call at the moment.
Audio is chopping at far-end in Hands-free speaker mode	<p>This is usually due to loud volume feedback from speaker to microphone. Please lower down the speaker volume a little bit, the chopping will be gone.</p>

Appendix I - Icon Illustration

Table 11 - Keypad Icons

















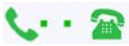

































	Redial
	Handsfree (HF) speaker
	Phone lock=long-pressed key(#)
	Mute microphone (during Call)
	Volume up
	Volume down

Table 12 - Status Prompt and Notification Icons

	Call out
	Call in
	Call hold
	Network disconnected
	Keypad locked
	Missed calls
	SMS
	New voice message waiting
	Do-not-disturb activated on phone
	Auto-answering activated
	Call forward activated
	Handsfree (HF) mode
	Headphone (HP) mode
	Handset (HS) mode
	Microphone muted
	Mixed type input
	Lower case input
	Upper case input
	Numeric input

Appendix II – Text Input from Keypad

Table 13 - Look-up Table of Characters

Mode Icon	Text Mode	Key Button	Characters Of Each Press
	Numeric		1
			2
			3
			4
			5
			6
			7
			8
			9
			0
			* #(space)@,./?<>[]%! &\$~+-
			#
			Lower Case Alphabets
	a b c		
	d e f		
	g h i		
	j k l		
	m n o		
	p q r s		
	t u v		
	w x y z		
	0		
	* #(space)@,./?<>[]%! &\$~+-		
	#		

ABC	Upper Case Alphabets	1	+ - * % / @ ! :
		2	A B C
		3	D E F
		4	G H I
		5	J K L
		6	M N O
		7	P Q R S
		8	T U V
		9	W Z Y X
		0	(space)
		*	* #(space)@,./?<>[]%! &\$~+-
		#	#
2aB	Mixed type input	1	1 + - * % / @ ! :
		2	2 a b c A B C
		3	3 d e f D E F
		4	4 g h I G H I
		5	5 j k l J K L
		6	6 m n o M N O
		7	7 p q r s P Q R S
		8	8 t u v T U V
		9	9 w z y x W Z Y X
		0	(space)
		*	* #(space)@,./?<>[]%! &\$~+-
		#	#

Appendix III – LED Definition

Table 14 - DSS KEY LED State

Type	LED Light	State
Line Key	Off	Line inactive
	Green On	Line ready (registered)
	Green Blinking	Dialing / ringing / call holding
BLF	Green On	Subscribed number is idle.
	Red On	Subscribed number is busy.
	Red Blinking	Subscribed number is dialing.
	Off	Subscribed number is unavailable
DND	Red On	Enable DND
	Off	Disable DND
MWI	Green On	New voice message waiting
	Off	No new voice message